

AutoPilot®

Owner's/Installation Manual

Pool Pilot®

Digital Nano/Nano+

Digital Nano	Models:	75041A, 75041A-xx
	Manifolds:	PPM1, PPM1M
	Cell:	PPC1
Digital Nano+	Models:	75043A, 75043A-xx
	Manifolds:	PPM2, PPM2M
	Cells:	PPC1 or PPC2

Including the Optional Pool Cover Detect Switch and the 1–28 Day Surface Cure Delay Instructions.



Important!

This manual covers the installation and operation of the Digital Nano / Nano+ Chlorine Generators. Read this manual and product labels before installing or operating this equipment.

INSTALLER: THIS DOCUMENT IS PURCHASER'S PROPERTY AND IS TO REMAIN WITH THE EQUIPMENT OWNER

Table of Contents

Section 1 - General Information	
1.1 Contacting AquaCal AutoPilot, Inc.	1
Section 2 - Safety Information	
2.1 Important Safety Instructions	1
Section 3 - Owner Quick Start & Run	
3.1 How Your Chlorinator Works	4
3.2 Owner / Operator Control Buttons, Check System LED and Audio Alarm	4
3.2.a UP and DOWN Arrows	4
3.2.b The BOOST Button	5
3.2.c MENU and SELECT Button	5
3.2.d CHECK SYSTEM Light and Audio Alarm	5
3.3 Normal Display Modes	6
3.3.a Purifier Mode	6
3.3.b Water Temperature	6
3.3.c CHECK SYSTEM Light	6
3.4 Water Balance and Chemistry Recommendations	6
Section 4 - Specifications and Approvals	
4.1 Agency Approvals	7
4.2 Specifications	7
4.3 Manifold Pressure Drop vs Flow	8
Section 5 - Features	
5.1 Patented Temperature Compensation	9
5.2 Water Manifold Assemblies - Available Options	9
5.2.a Automatic - Flow Bypass Manifold Assembly	10
5.2.b CoPilot Manifold Assembly	10
5.3 Additional Features with the 863A Expansion Board Option	11
5.3.a Automatically Reduce Chlorine Output When Pool Cover Closes	11
5.3.b 12/24 Hour Clock Display	12
5.3.c Set Purifier Off	12
Section 6 - Maintenance	
6.1 Fuse Location and Ratings	12
6.2 Removing / Inspecting / Cleaning Tri-sensor	13
6.2.a Tri-sensor Assembly Overview	13
6.2.b Inspect Tri-sensor	13
6.2.c Cleaning Tri-sensor / Salt Sensor	14
6.2.d Test Tri-sensor Flow Switch	14
6.3 Servicing the Cell	15
6.3.a Removal	15
6.3.b Visual Inspection	15
6.3.c Manual Cleaning	16
6.3.d Installing	16
6.4 Winterizing	17
6.4.a Control Unit and Manifold Assembly	17
6.5 Spring Start Up	17

Section 7 - Programming

7.1 Control Panel	18
7.1.a Button Overview	18
7.1.b MENU / SELECT Button	18
7.1.c Display Overview	18
7.2 Menus	19
7.3 Basic Operational Programming	20
7.3.a Adjusting the Purifier Output %	20
7.3.b Boost or Super Boost	20
7.3.c Purifier Mode	20
7.3.d Purifier % Adjustment Procedure	21
7.4 Test Pool Pilot (Diagnostic Menu)	21
7.5 View Setup	22
7.6 Review Of Installer, Owner, & Maintenance Menu Programming	22
7.6.a Set Pool Volume	22
7.6.b Calibrate Salt	22
7.6.c Select Language	23
7.6.d Calibrate Temperature	23
7.6.e Select Units	23
7.6.f Set Temperature Unit	23
7.6.g Display Temperature	24
7.6.h Set Reverse Time	24
7.6.i Force Reverse	24
7.6.j Enable / Disable Audio Alarm	24
7.7 Menu Programming-Optional 863A Expansion Board Features	25
7.7.a Display time	25
7.7.b Set 12/24 Hour Clock	25
7.7.c Set Time of Day	25
7.7.d Select System	25
7.7.e Set Purifier Off	26

Section 8 - Installation

8.1 Basic System Overview	27
8.2 Planning the Installation	28
8.3 Check Parts	28
8.4 Installation Steps	28
8.5 Plumbing The System	29
8.5.a Plumbing the Manifold Assembly	29
8.6 Mounting the Chlorinator	30
8.7 Electrical Connections	30
8.7.a Electrical Connections Overview	30
8.7.b AC Input Voltage	31
8.7.c Low Voltage Wiring	32
8.7.d Installing the Optional 863A Expansion Board	32
8.7.e Connecting the Retractable Cover Switch (Option only available with purchase of #863A Expansion Board)	34
8.7.f Bonding	34

8.8 Preparing the Pool Water	35
8.8.a Calculating Pool Volume	35
8.8.b Steps to Prepare Water	35
8.8.c Adding Salt	36
8.9 Programming at Installation	37
Section 9 - Troubleshooting	
9.1 Troubleshooting	37
9.2 Additional Troubleshooting for Units Equipped with Optional 863A Expansion Board	44
Section 10 - Reference	
10.1 Basic Water Chemistry	44
10.1.a Chlorine	46
10.1.b pH	46
10.1.c Total Alkalinity	46
10.1.d Calcium Hardness	46
10.1.e Cyanuric Acid	46
10.2 Using the Saturation Index	47
10.3 Salt Addition Chart	48
Section 11 - FCC Compliance	
11.1 FCC Compliance	49

SECTION 1 - GENERAL INFORMATION

1.1 Contacting AquaCal AutoPilot, Inc.

If you need to contact AquaCal AutoPilot, Inc. for questions, services, or parts, please have your model and serial numbers available. Also have the name of your installer and date of your equipment's installation. Please refer to our website for the latest manual revisions, additional information, and helpful service advice.

Website	www.autopilot.com	Pool volume (Gallons / Liters)	
Phone	(727) 823-5642	Installer:	
Fax	(727) 821-7471	Installation Date:	
Address	AquaCal AutoPilot, Inc. 2737 24th Street North St. Petersburg, FL 33713, USA	Cell Type:	
		Cell Serial #:	
		Model Type:	
		Model Serial #:	

SECTION 2 - SAFETY INFORMATION

2.1 Important Safety Instructions

When installing and using this electrical equipment, basic safety precautions should always be followed, including the following:

READ AND FOLLOW ALL INSTRUCTIONS.

- A green colored terminal or terminal marked G, GR, Ground, Grounding, or the symbol  is located inside the power center terminal box or compartment. To reduce the risk of electric shock, this terminal must be connected to the grounding means provided in the electric service panel with a continuous copper wire equivalent in size to the circuit conductors supplying this equipment.
- Follow all state, local, and National Electrical Code(s) (provincial and Canadian Electrical Code(s) if applicable) unless local guidelines supersede.
- For personal safety, and to avoid damage to equipment, follow all safety instructions displayed on the equipment and within this manual. Repair and service of your AutoPilot® chlorinator must be performed by qualified service personnel.
- Should you suspect your chlorine generator is not performing properly, refer to the Troubleshooting section in this manual to determine if service is required. See "Troubleshooting" on page 37.
- Warranties will be voided if the chlorinator has been improperly installed. Failure to properly operate, maintain or repair the AutoPilot® chlorinator will void the factory warranty.

SAFETY SIGNALS

Throughout this manual safety signals are placed where particular attention is required.



WARNING - Failure to heed the following may result in permanent injury or death.



CAUTION - Failure to heed the following may result in equipment damage.

- ⚠ WARNING - Failure to heed the following may result in permanent injury or death.**
- **RISK OF ELECTRICAL SHOCK** - Disconnect all AC power when installing or servicing this system. Follow all state, local, and National Electrical Code(s) (provincial and Canadian Electrical Code(s) if applicable). Use copper conductors only.
 - **RISK OF ELECTRICAL SHOCK** - To reduce risk of electrical shock, replace damaged cord immediately.
 - **RISK OF ELECTRICAL SHOCK** - The AutoPilot® chlorinator contains no owner-repairable components. Repairs must not be attempted by untrained and / or unqualified individuals. If service is deemed necessary, contact installing dealer or AquaCal AutoPilot Customer Support.
 - **RISK OF ELECTRICAL SHOCK** - A bonding lug has been provided on the outside of the power supply. This lug permits the connection of a No. 8 AWG (8.4 mm²) solid copper-bonding conductor (No. 6 AWG in Canada). Make this connection between the Pool Pilot® power supply and all other electrical equipment and exposed metal within 5 ft (1.5 m) of the unit. All field-installed metal components (such as rails, ladders, drains, etc.) within 10 ft (3 m) of the pool, spa, or hot tub, must be bonded to the equipment grounding bus using copper conductors not smaller than No. 8 AWG (8.4 mm²) (No. 6 AWG in Canada).
 - **RISK OF ELECTRICAL SHOCK** - The AutoPilot® chlorinators configured to 115 Vac must be installed at least 10 ft (3 m) from the pool or spa wall. Pool Pilot® chlorinators configured to 230 Vac must be installed at least 5 ft (1.5 m) from the pool or spa wall.
 - **RISK OF ELECTRICAL SHOCK** - A disconnect device incorporated into the fixed wiring must be included in the supply circuit (such as a time clock, relay, or circuit breaker).
 - **RISK OF ELECTRICAL SHOCK** - Connect only to a branch circuit protected by a ground-fault circuit-interrupter (GFCI). Contact a qualified electrician if you cannot verify that the circuit is protected by a GFCI.
 - **RISK OF ELECTRICAL SHOCK** - The AutoPilot® chlorinator must be connected only to a supply circuit that is protected by a ground-fault circuit-interrupter (GFCI). The GFCI must be tested on a routine basis. To test, push the GFCI test button. Power should be interrupted. Push the reset button. Power should be restored. If the GFCI fails to operate in this manner, it is defective.
 - **RISK OF ELECTRICAL SHOCK** - If the ground-fault circuit-interrupter (GFCI) interrupts power to the equipment without the test button being pushed, a ground current is flowing with a possibility of an electrical shock. Do not use equipment. Disconnect the equipment and have the problem corrected by a qualified service representative before using.
 - **CHEMICAL HAZARD** - To avoid damaging splashes, always add acid to water, never water to acid. Wear safety glasses and use other appropriate personal protection equipment.
 - **CHEMICAL HAZARD** - Always follow the instructions on the manufacturer's label whenever handling or using chemicals.
 - **CHEMICAL HAZARD** – Heavy pool (or spa) usage and higher temperatures may require a higher chlorine output in order to maintain proper free available chlorine residuals.
 - **WATER CHEMISTRY SAFETY** - Improper water chemistry can present a serious health hazard. The proper residual chlorine level and water chemistry must be maintained. The addition of certain pool maintenance chemicals can reduce the effectiveness of chlorine. Maintain pool/spa water per standards detailed later in this manual.
 - **COMBUSTIBLE HAZARD** – The AutoPilot® chlorinator is equipped with an electronic flow switch that automatically turns the unit off in the event of a “low water flow” situation. Do not tamper in any way with this safety feature.
 - **PERSONAL SAFETY HAZARD** – To reduce risk of injury, do not permit children to operate this device.
 - **RISK OF CHILD DROWNING OR INJURY** - Children must be closely supervised at all times around pool or spa equipment.

 **CAUTION** - Failure to heed the following may result in equipment damage.

- The Pool Pilot® must be installed and operated as specified. Failure to do so will void the equipment warranty.
- To permit proper air circulation, the power supply must be mounted at least 1 ft (30 cm) above ground level or any other air flow obstruction.
- Special measures are required in the event of freezing conditions. Your chlorinator may be damaged if measures are not taken in advance of freezing conditions. Equipment damage due to freezing conditions is NOT covered under the equipment warranty.
- Do not use a pool cleaner or vacuum head with wheels, as wheels can leave track marks on newly-plastered pools. Do not allow granular salt to pile up in one location without brushing, as staining may occur.
- For all newly constructed or resurfaced plaster pools: Do not operate the Pool Pilot® with newly poured or resurfaced pool plaster. Before adding salt and operating the chlorinator, wait 30 days after construction is completed to allow proper curing of the surface material. Follow the pool surface manufacturer's guidelines for your specific pool.
- FOR NEW VINYL LINER POOLS, contact the manufacturer for recommended instructions before adding salt and operating the chlorinator.
- Salt is an inherently corrosive material. While the recommended level of salt for your AutoPilot® product should not damage your equipment, excessively high chlorine levels can cause corrosion damage to pool fixtures and equipment. Consult your pool professional for equipment selection, proper use and maintenance of these products.
- For maximum cell life, maintain water in a balanced condition. Water maintained in a scaling condition will shorten cell life and may render the Pool Pilot® inoperative. Damage and / or service calls caused by improper water balance will NOT be covered under the equipment warranty.
- Scraping or scratching the titanium blade's edge or surface will damage the blade catalyst coating and cause premature failure of the cell. Never use any sharp or metallic objects to remove scale. The warranty will be voided.
- Reduced polarity reversing cycle times will reduce cell life, and should only be used due to uncontrollable scale formation on the cell. ALWAYS test and adjust water balance before attempting scale control via shortening reverse period.

SAVE THESE INSTRUCTIONS

SECTION 3 - OWNER QUICK START & RUN

1. Balance the water chemistry according to the water chemistry parameters and salt recommendations. See "Water Balance and Chemistry Recommendations" on page 6. See "Preparing the Pool Water" on page 35.
 - The Pool Pilot® may be started immediately. The salt reading, however, may initially be inaccurate until the circulation pump has been run for 24 hours to fully dissolve newly added salt.
2. Use the UP and DOWN arrow buttons to set the purifier percentage to 50%. Press SELECT to save setting.
3. During the first two weeks, test the water chemistry parameters every 3 - 4 days. Adjust purifier percentage as needed.
4. Once ideal purifier percentage has been determined, follow normal maintenance procedures.

3.1 How Your Chlorinator Works

The Pool Pilot® is designed to handle the purification needs of residential swimming pools and spas. The amount of chlorine required for proper sanitization will vary based on the pool size and factors such as water temperature, bather load, exposure to direct sunlight, and special water features.

The system requires a low concentration of dissolved salt (sodium chloride) in the water. The salt concentration is normally maintained below the taste threshold. The unit automatically converts salt into chlorine, which your pool/spa requires to remain sanitized and algae free. The chlorine reverts back to salt after treating the water. Since the salt is constantly recycled, there is minimal loss during a swimming season. However, salt can be lost due to filter back washing, rain water overflow, leaks, or bather splashing/carry out, but not through evaporation.

The water circulation pump must be operating for your Pool Pilot® to produce chlorine, so run time is one of several key factors to maintaining proper sanitizer levels. Most installations require a minimum of eight (8) hours-per-day pump run time to properly filter and sanitize the water.

3.2 Owner / Operator Control Buttons, Check System LED and Audio Alarm

This section assumes the installer has already programmed the system for specific site parameters, has established proper water balance, and has pretreated water to 1-3 ppm (mg/L) chlorine.

Should Celsius vs. Fahrenheit, language preference, or other owner options require modification, refer to the "Programming" section of this manual. See "Review Of Installer, Owner, & Maintenance Menu Programming" on page 22.

This section contains a brief explanation of owner or operator control buttons.

3.2.a UP and DOWN Arrows

Use the UP and DOWN arrows to control the purifier output level.

After output level is adjusted, press the SELECT button to save the value chosen. With a properly prepared pool, the recommended starting output level is 50%.

Upon initial start-up, check sanitizer every 3 - 4 days and make small output level adjustments as necessary to maintain 1 - 3 ppm (mg/L) free chlorine levels. Keep in mind, your Pool Pilot® does not directly measure or regulate the sanitizer levels in your pool. Rather, the owner/operator will need to periodically test the water to determine the current chlorine level and adjust the output setting as needed.

After the chlorine output level is “tuned in,” the unit will automatically make fine output adjustments as the water temperature fluctuates. This temperature compensation feature will adjust output depending on water temperature. See "Patented Temperature Compensation" on page 9.

Note: The optimum output setting will vary based upon pool size, location, exposure to sunlight, number of users, vegetation around the pool, water balance practices, and pump run time. Your installer should have already taken these factors into consideration when performing installation programming. Therefore, your adjustments at this point should be relatively minor.

3.2.b The BOOST Button

The BOOST button increases output to 100%. Use this feature when a heavier than normal bather load is anticipated.

Press BOOST once..... = 24 Hour Boost

Press and hold BOOST for 8 seconds..... = 72 Hour Boost

Press BOOST a second time..... = Deactivate Boost

3.2.c MENU and SELECT Button

The MENU button allows the operator access to the “Test Pool Pilot”, “View setup”, “Owner options”, “Maintenance” and “Installer” menus. See "Review Of Installer, Owner, & Maintenance Menu Programming" on page 22.

Press the UP and DOWN arrows to scroll through the menus.

The SELECT button allows the operator to choose program menu options. The owner/operator should not normally need to access these features on a regular basis.

Consult the "Programming" section for additional information related to the MENU and SELECT buttons. See "Control Panel" on page 18. For an overview of all the menus & sub-menus, consult the "Menus" section. See "Menus" on page 19.

3.2.d CHECK SYSTEM Light and Audio Alarm

The CHECK SYSTEM light will flash to warn the unit may need attention. A warning message will also be displayed. If enabled, an audio alarm* may also be heard when the system light is flashing. Unless deemed a normal condition per below, refer to the "Troubleshooting" section.

- Flashes red when pump is off or water flow is insufficient (It is normal for the light to flash if the circulation pump is off)
- Flashes when salt is low (check salt and add as needed)
- Flashes when water temperature exceeds 125° F (51° C), or drops below 10° F (-12° C)

*Note: When enabled, an audio alarm will sound due to any of the above three (3) conditions. If water flow ceases (or falls below minimum acceptable levels) the alarm will automatically silence after 10 minutes. See "Enable / Disable Audio Alarm" on page 24.

3.3 Normal Display Modes

3.3.a Purifier Mode

Purifier (Chlorine Output %) level.....Shown in 1% increments

- Range with cover open 0% to 100%
- Range with cover closed 0% to 20%

3.3.b Water Temperature

Displayed in Fahrenheit or Celsius.

The Temperature can be turned off. See "Display Temperature" on page 24.

3.3.c CHECK SYSTEM Light

Off when operating normally. Normally blinking red when circulation pump is off and supply power to the Pool Pilot® remains on. The light will also blink red when an error has occurred. See " Troubleshooting" on page 37.

3.4 Water Balance and Chemistry Recommendations

Water balance is the relationship between different chemical measurements in your pool water. A pool that is balanced has proper levels of pH, Total Alkalinity and Calcium Hardness. Balanced water can also be defined as water that is not corrosive or scaling. Water that is not balanced can damage equipment and pool surfaces. See "Basic Water Chemistry" on page 44.

Proper water chemistry levels are essential to maintain safe and consistent swimming pool operation. Sanitizers are used to destroy harmful or otherwise objectionable organisms. Stabilizer or Cyanuric Acid (CYA) is used in many regions to reduce unnecessary loss of chlorine to sunlight. Salt is used by the Pool Pilot® to generate chlorine sanitizer.

Please note the following recommended water chemistry parameters are for residential pool/spa applications only. Follow local regulatory guidelines for any commercial pool applications.

Table 1

Parameter	Units	POOL			SPA		
		Min	Ideal	Max	Min	Ideal	Max
Free Chlorine	ppm mg/L	1.0	2.0 - 4.0	5	2.0	3.0 - 4.0	10
Combined Chlorine	ppm mg/L	0.0	0.0	0.2	0.0	0.0	0.5
pH	-	7.2	7.4 - 7.6	7.8	7.2	7.4 - 7.6	7.8
Total Alkalinity	ppm mg/L	60	80 - 100	180	60	80 - 100	180
Calcium Hardness	ppm mg/L	150	200 - 400	1,000	100	150 - 250	1,000
Salt	ppm mg/L	2,000	3,500 - 4,500	**	2000	3,500 - 4,500	**
Cyanuric Acid (stabilizer)	ppm mg/L	0	30 - 50	***	0	30 - 50	***

** Typically 6,000 ppm (mg/L) or less is recommended; unit can operate with levels as high as 35,000+ ppm (mg/L).

*** This is dictated by state or local codes but is typically 80 ppm (mg/L).

See "Basic Water Chemistry" and "Using the Saturation Index" sections later in this manual for further information concerning pool/spa water chemistry maintenance requirements. Refer to the "Troubleshooting" section for assistance with resolving low or high chlorine issues.

SECTION 4 - SPECIFICATIONS AND APPROVALS

4.1 Agency Approvals

Tested to conform to the following specifications:

SPECIFICATION	DESCRIPTION
UL1081	Safety Standard for Swimming Pool Pumps, Filters and Chlorinators.
CAN / CSA-C22.2#218.2	Safety of Household and Similar Electrical Appliances.
FCC	See "FCC Compliance" on page 49.

4.2 Specifications

SPECIFICATION	75041A, 75041A-XX (when converted to 110V-120V in the field)	75041A, 75041A-XX	75043A, 75043A-XX (when converted to 110V-120V in the field)	75043A, 75043A-XX
Input Power:	110-120 Vac 2.0 A	220-240 Vac 1.0 A	110-120 Vac 2.0 A	220-240 Vac 1.0 A
Cell Maximum Chlorine Output:				
PPC1	0.8 lb. / day (15.1 g/hr) (standard)		0.8 lb. / day (15.1 g/hr) (standard)	
PPC2	not applicable		1.06 lb. / day (20.0 g/hr) (standard)	
Manifold Type	PPM1 & PPM1M		PPM2 & PPM2M	
Standard Cell	PPC1		PPC2	
Manifold Flow rates:				
PPMxx (standard)	Minimum 20 gpm (76 L/min); Maximum 70 gpm (265 L/min)			
CoPilot Ozone (optional)	Minimum 25 gpm (95 L/min); Maximum 70 gpm (265 L/min)			
Maximum Manifold Pressure	75 psi (586 kPa)			
Cover Switch Compatible Models	75041A & 75043A (Discontinued models 75040A & 75042A)			

4.3 Manifold Pressure Drop vs Flow

The following chart shows pressure drop versus flow for all AutoPilot® manifolds. The optional CoPilot® Ozone manifold is also listed.

Table 3

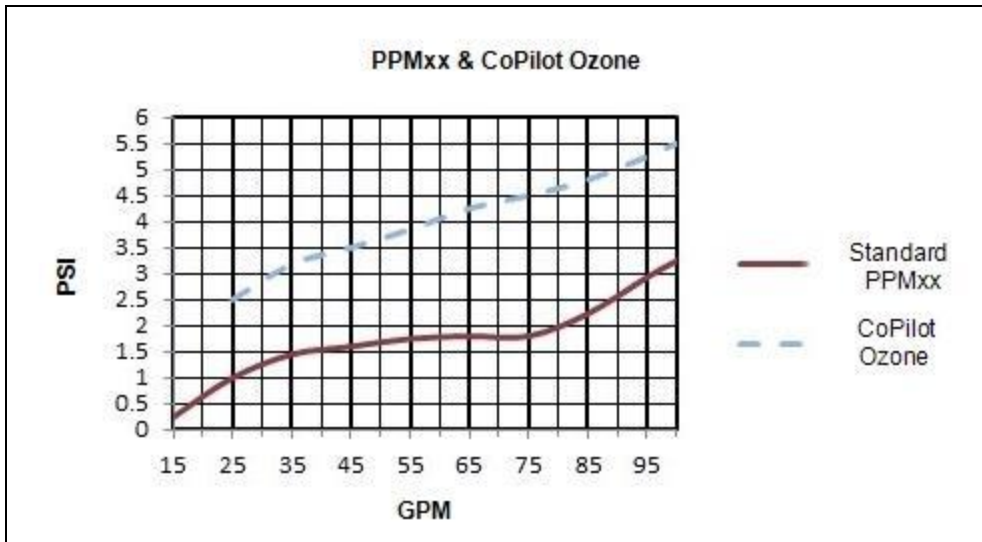
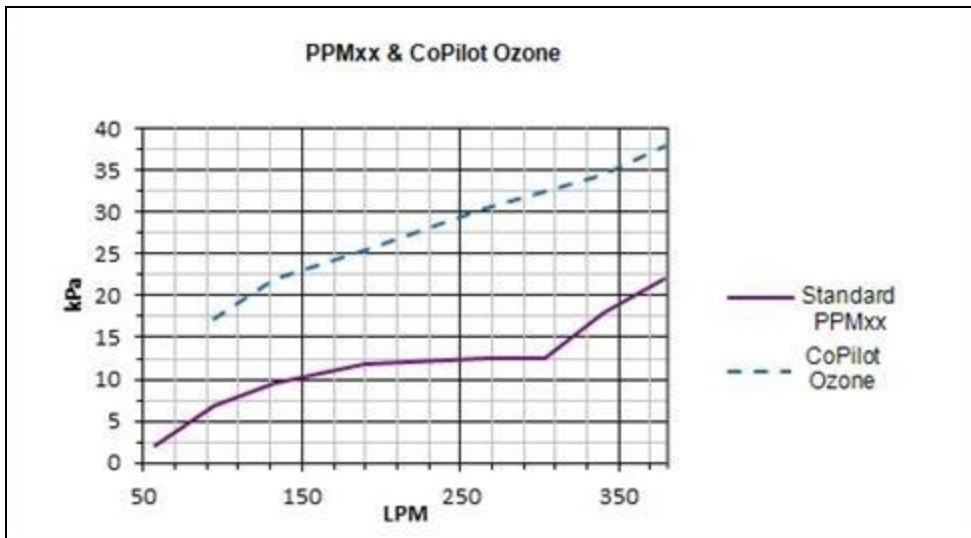

Table 4



SECTION 5 - FEATURES

- Patented temperature compensation for chlorine output control.
- Programmable microprocessor control.
- Multi-language digital display (English, Spanish, French, German, Italian and Czech).
- Digitally controlled power to the cell.
- Tri-sensor circuitry to monitor water flow, water temperature, and salt level.
- Calculates and displays amount of salt needed to reach the recommended 3,000 ppm (mg/L) salt concentration level.
- On board diagnostic and test programs.
- Optional CoPilot[®] upgrade brings Ozone to the pool.
- Can automatically reduce purifier output when pool cover is closed. (Optional 863A Expansion Board and Cover Switch must be installed.)
- Chlorine production (salt addition) can be delayed for up to 28 days. (Optional 863A Expansion Board)

5.1 Patented Temperature Compensation

⚠ WARNING - Failure to heed the following may result in permanent injury or death.

- Pool or spa water temperature should not exceed 104°F (40°C).

The water temperature sensor works in conjunction with the purifier % feature to automatically adjust chlorine output based upon changes in water temperature. This feature operates between 55°F and 125°F (13°C - 52°C).

As water temperature falls below 65°F (18°C), the controller will automatically reduce the purifier % and will reduce the maximum % that can be selected. This feature prevents the controller from generating excessive chlorine in cold water where it is not needed and prevents premature cell failure.

At 55°F (13°C) or colder water temperatures, the controller will adjust to a fixed 1% output, thus preventing over-chlorination and premature cell failure.

5.2 Water Manifold Assemblies - Available Options

⚠ CAUTION - Failure to heed the following may result in equipment damage.

- The Digital Nano manifold may only use the PPC1 cell. The Digital Nano+ may use either the PPC1 or PPC2 cell.

The Digital Nano uses the automatic-flow bypass manifold assembly (models PPM1, PPM1M). The Digital Nano should only use the PPC1 cell.

The Digital Nano+ uses the patented automatic-flow bypass manifold assembly (models PPM2, PPM2M) with a PPC2 cell. The Digital Nano+ may also use a PPC1 cell, but the maximum chlorine output will be lower. See "Specifications" on page 7.

The CoPilot[®] manifold assembly comes with an automatic-flow bypass, check valve assembly and ozone injector venturi assembly.

5.2.a Automatic - Flow Bypass Manifold Assembly

Models PPM1, PPM1M and PPM2, PPM2M:

The AutoPilot® manifold is connected into the plumbing after all other equipment. Water from the pool/spa is moved through the manifold by the circulation pump. The manifold uses four key components:

- The **Tri-sensor** provides data (from electronic sensors) to the Pool Pilot® for monitoring water flow, water temperature, and salt concentration level. The Pool Pilot® uses this data to determine if conditions are suitable for the cell to operate; the signal read from the temperature sensor allows the automatic temperature compensation feature to function.
- The **Cell** (PPCx) receives power from the Pool Pilot® and converts the salt contained in the water to chlorine.
- The **Strainer Screen** prevents debris in the water from entering the Tri-sensor or cell, and requires periodic inspection and cleaning.
- The **Bypass Check Valve** allows the water flow rate to be slowed and optimized through the cell, while permitting the pump to continue to circulate water to-and-from the pool / spa at full flow rates. The reduced water flow through the cell results in a more efficient "Super-Chlorination" effect, resulting in improved overall sanitization.

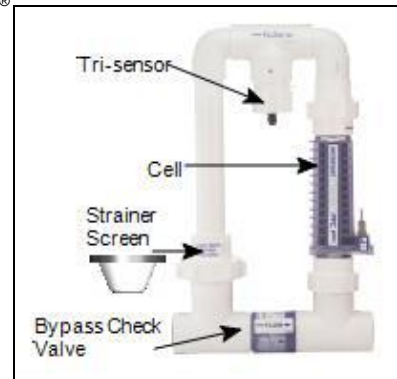

Figure 1

5.2.b CoPilot Manifold Assembly

The CoPilot® system is designed to be used in conjunction with the Pool Pilot® to reduce chlorine demand and extend cell life. This system is also sold separately as an upgrade to existing Pool Pilot® systems.

The manifold is connected into the plumbing after all other equipment. Water from the pool/spa is moved through the manifold by the circulation pump:

- The **Tri-sensor** provides data (from electronic sensors) to the Pool Pilot® for monitoring water flow, water temperature, and salt concentration level. The Pool Pilot® uses this data to determine if conditions are safe for the cell to operate; the signal read from the temperature sensor allows the automatic temperature compensation feature to function.
- The **Cell** (PPCx) receives power from the Pool Pilot® and converts the salt contained in the water to chlorine.
- The **Strainer Screen** prevents debris in the water from entering the Tri-sensor or cell, and requires periodic inspection and cleaning.
- The **Bypass Check Valve** allows the water flow rate to be slowed and optimized through the cell, while permitting the pump to continue to circulate water to-and-from the pool/spa at full flow rates. The reduced water flow through the cell results in a more efficient "Super-Chlorination" effect, resulting in improved overall sanitization.
- The **Ozone Venturi Injector** introduces ozone directly into the water before the Pool Pilot® cell. The ozone venturi injector is connected to the CoPilot® via an Ozone Check Valve and Tube Assembly (not shown).



Figure 2

5.3 Additional Features with the 863A Expansion Board Option

When the optional 863A Expansion Board is purchased and installed, your Digital Nano/Nano+ will be equipped with a variety of additional features.

5.3.a Automatically Reduce Chlorine Output When Pool Cover Closes

Once installed, the new board will support the addition of an automatic pool cover switch (not supplied) that will detect when the pool cover is open or closed. This will allow the Digital Nano/Nano+ to automatically reduce purifier output when the cover is closed and avoid over chlorination or premature cell depletion.

Units equipped with the optional Expansion Board will show "cover closed" if connected to a cover switch and the cover is in the closed position. With the cover closed, the purifier is reduced to 20% of the original setting.

If the optional 863A Expansion Board has been installed along with the pool cover switch, two purifier % numbers will be displayed. The left one is the value when the pool cover is open and the right is when the cover is closed.

Example of purifier adjustment display.



Example with the Retractable Pool Cover Open and the Temperature Display on.

Cell Status..... will show "ON" when chlorine is being generated. Field will be blank when the cell is off.



Example with the Retractable Pool Cover Closed and Temperature Display off.

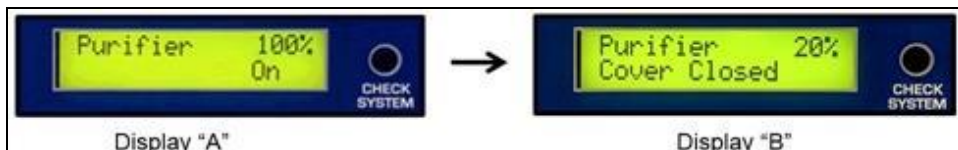

This only applies to models that are equipped with the optional 863A Expansion Board and the cover position switch is connected to the unit. See "Connecting the Retractable Cover Switch (Option only available with purchase of #863A Expansion Board)" on page 34.

Caution: Regardless of retractable pool cover position, when the Boost feature is activated the unit will increase chlorine production to 100% for 24 or 72 hours based on the Boost time selected.

5.3.b 12/24 Hour Clock Display

A 12/24 Hour Clock that allows the user to set personal preference for time display. The Set Time of Day feature can be set to display the correct time zone and/or adjustments for Daylight Saving Time changes.

5.3.c Set Purifier Off

The Set Purifier Off feature will allow the Digital Nano/Nano+ to be programmed to delay chlorine production if salt will not be added to the pool water for a specified amount of time, from 1-28 days, or if there is a need to halt chlorine production for a set amount of time.

SECTION 6 - MAINTENANCE

6.1 Fuse Location and Ratings

WARNING - Failure to heed the following may result in permanent injury or death.

- ELECTRICAL SHOCK HAZARD – Turn off the electrical power to unit before servicing.

To inspect or service the fuse, disconnect power and remove the power center cover (see below for location of fuse).

Ratings

BOARD	FUSE SPECIFICATION	DESCRIPTION
Main Power Board When Converted to 115V 75041A, 75043A, 75041A-xx, 75043A-xx	250 Vac 2 Amp Slo Blo	AC Power Fuse for 115 Vac Operation
Main Power Board (Factory set as 230 Vac) 75041A, 75043A, 75041A-xx, 75043A-xx	250 Vac 1 Amp Slo Blo	Main AC Power Fuse for 230 Vac Operation

Location of Fuse

110V - 120V Configuration

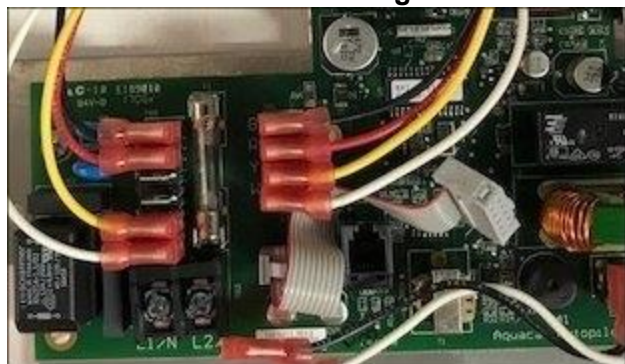

Figure 3

220V - 240V Configuration



Figure 4

6.2 Removing / Inspecting / Cleaning Tri-sensor

6.2.a Tri-sensor Assembly Overview

The Tri-sensor assembly is used to measure water flow, salt level, and water temperature.

Note: The use of high strength magnet devices in the close proximity of the Tri-sensor can cause the flow switch to function incorrectly.

- When the water flow reaches a minimum flow rate of 20 gpm (76 L/min), the flow paddle magnet closes a micro-switch monitored by the Pool Pilot®. (The CoPilot® Ozone manifold requires a minimum flow of 25 gpm (95 L/min).)
- The Pool Pilot® uses dedicated salt sensor blades to measure the level of salt in the water.
- The Pool Pilot® uses the temperature sensor to determine water temperature. This measurement is required for the Patented Automatic Temperature Compensation feature to automatically adjust chlorine output as water temperature varies. Less chlorine is needed in cold water, so chlorine output is automatically reduced as water temperature drops (avoiding excess chlorine production).

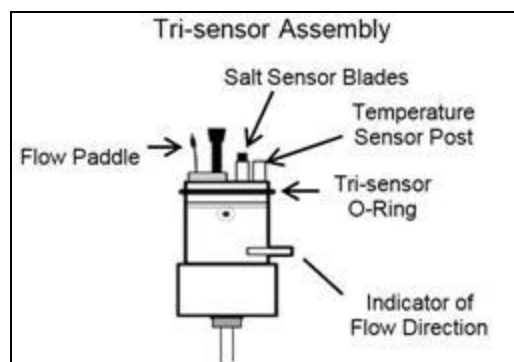

Figure 5

- Conversely, more chlorine is needed in warmer water, and production is automatically adjusted higher as water temperature increases.
- Please note - The Tri-sensor normally does not require maintenance or cleaning.

6.2.b Inspect Tri-sensor

1. Disconnect the Tri-sensor cable from the power center.
2. Remove the two (2) screws retaining the Tri-sensor in the Tee joint of the manifold.
 - Note the orientation of the Direction of Flow Tab. The Tri-sensor must be installed in the same orientation when it is reinstalled or replaced.
3. The Tri-sensor can now be pulled out of the Tee.

⚠ CAUTION - Failure to heed the following may result in equipment damage.

- The Tri-sensor should not be removed from manifold at an angle or the flow paddle and/or flow post may be damaged.
 - Firmly grip the Tri-sensor assembly (this is typically done with a large pair of channel lock pliers).
 - Twist the Tri-sensor back-and-forth while simultaneously pulling the Tri-sensor straight out of the Tee joint.
4. Check the Tri-sensor assembly for any damage to the plastic housing and replace if needed.
 5. Inspect the following on the flow switch:
 - Verify the thin metallic paddle is straight and free from erosion.
 - Verify the plastic post is straight and free of cracks. (Do not twist or bend the paddle or the plastic post.)
 6. Inspect the two salt sensor blades. The blades should not have any mineral deposits (scale) or other debris on them.
 - Do not use any metallic objects to scrape the blade surfaces or you will remove or damage the blade sensor coating.

6.2.c Cleaning Tri-sensor / Salt Sensor

If required, you can remove a calcium scale buildup by creating a solution of water and muriatic acid as follows. Do not use any metallic objects to scrape the blade surfaces or you will remove or damage the blade sensor coating.

⚠ WARNING - Failure to heed the following may result in permanent injury or death.

- **CHEMICAL HAZARD** - To avoid damaging splashes always add acid to water, never water to acid. Wear appropriate personal safety protection including safety glasses when using pool chemicals.
1. Mix the solution in a small container tall enough to cover the sensor blades. **DO NOT** add water to acid; always add acid to water in container.
 2. Mix one (1) part muriatic acid into four (4) parts water.
 3. Immerse the salt sensor blades in the solution for up to fifteen (15) minutes. An effervescing action indicates the calcium is being dissolved from the blades.
 4. Rinse with fresh water and re-inspect. Repeat the acid treatment as necessary until all scale has been eliminated.

6.2.d Test Tri-sensor Flow Switch

⚠ WARNING - Failure to heed the following may result in permanent injury or death.

- Do **NOT** operate system with a faulty water flow switch.

The Flow Switch is a critical equipment protection device to prevent damage to the cell or system. When water flow has stopped, power to the cell is automatically turned OFF. It is important to verify the proper operation of the Tri-sensor's water flow switch protection device.

The following procedure can be used to verify the proper operation of the flow switch or to flush debris from the bypass valve.

1. Turn off the circulation pump.
2. Slightly loosen the union nut just below the cell on the side of the manifold that does not contain the filter screen. (A strap wrench may be required.)
3. Completely loosen the manifold union nut that contains the filter screen and pivot the manifold to gain access to the filter screen.
4. Remove the screen. Clean the screen if dirty.
5. If the screen was dirty, then the system may need to be purged to remove excess debris. Leave the manifold off and run the pump for a few seconds until clear.
6. Wrap the strainer screen securely with a small piece of plastic wrap (saran wrap, food wrap or zip lock bag) as indicated in the diagram, place it back in the union.
7. Tighten the two unions that were loosened. Do not over tighten.
8. Turn on the pump and the Pool Pilot®. The plastic will stop water flow to the flow switch, which is part of the Tri-sensor that is located in the upper portion of the manifold. All water will be forced through the bypass valve. This action will normally flush out any small bits of debris trapped in the bypass valve.
9. The Pool Pilot® should detect a low water flow at the Tri-sensor and activate the red CHECK SYSTEM light. The Pool Pilot® will also display the message "Error purify off"; "Check flow".
10. If the Pool Pilot® did not display this warning, check the Tri-sensor cable connections and inspect and clean the Tri-sensor as outlined in the "Inspect Tri-sensor" and "Cleaning Tri-sensor" sections. If the warning message still does not appear, turn the Pool Pilot® off and contact the factory or your local dealer for assistance.
11. Turn the pump off.
12. Loosen the unions.
13. Remove the plastic wrap and replace the strainer screen. Tighten the unions.
14. Resume normal operation.

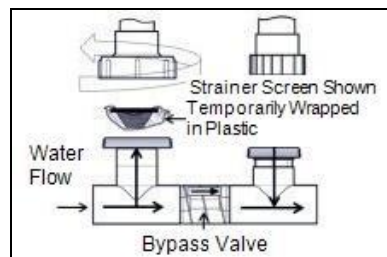

Figure 6

6.3 Servicing the Cell

The cell may require removal for periodic visual inspections, or for servicing when debris or calcium mineral deposits develop. The need to inspect and service the cell is indicated by the CHECK SYSTEM light flashing and/or a screen message, "Error purify off"; "Check flow" or "Warning!"; "Check/clean cell".

6.3.a Removal

The cell is installed with unions on each end to allow quick and easy installation and removal.

1. Turn off the circulation pump and shut off all power.
2. Unscrew the unions at both ends of the cell. (A strap wrench may be required.)
3. Slide the cell out of the manifold assembly.
4. Inspect the cell - **If cleaning is necessary, detach cell cord from the cell.**

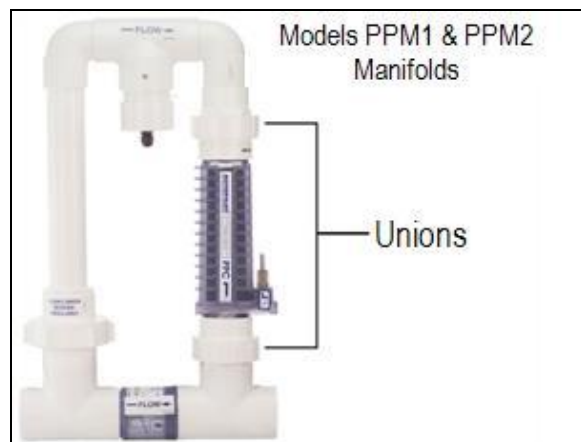

Figure 7

6.3.b Visual Inspection

Your Pool Pilot® is designed to automatically self-clean calcium scale build up that may form on the blades during normal operation. However, unbalanced water chemistry can cause a heavy scale build up exceeding self-cleaning capabilities. Periodic manual cleaning may be necessary. The simplest way to avoid this extra work is to maintain the water chemistry at the levels recommended.

1. The cell titanium blades, seen inside the cell body, should be straight and clear of any debris on the ends or between the blades.
2. White, flaky or crusty calcium build up on the edge or between the blades will shorten the life of the cell. If required, clean the cell immediately and determine the cause of scaling. See "Basic Water Chemistry" on page 44. See "Using the Saturation Index" on page 47.

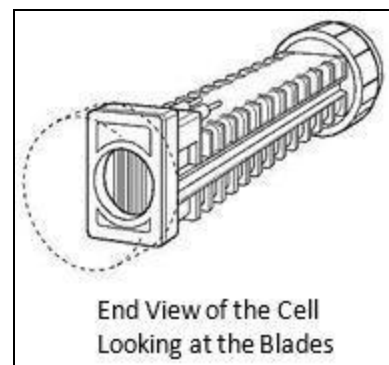

Figure 8

6.3.c Manual Cleaning

- ⚠ WARNING** - Failure to heed the following may result in permanent injury or death.
- **CHEMICAL HAZARD** - To avoid damaging splashes always add acid to water, never water to acid. Wear safety glasses and use other appropriate personal protection equipment.

- ⚠ CAUTION** - Failure to heed the following may result in equipment damage.
- Scraping or scratching the titanium blade's edge or surface will damage the blade catalyst coating and cause premature failure of the cell... warranty will be voided. Never use any sharp or metallic objects to remove scale.

1. Place a PLA0113 cell cleaning plug (AutoPilot® accessory) on the end of the cell as shown. A 1 ½" MPT clean out plug may also be used and can be purchased in the PVC plumbing section at most pool supply or home improvement stores.
2. Fill the capped cell with water two (2) inches from the top of the cell blades.
3. Fill the rest of the cell with muriatic acid. This allows for an approximate 1-to-4 solution. Always add the acid to the water. If you do it the other way around, it can cause the solution to spray back causing serious injury.
4. Allow the solution to sit in the cell for fifteen (15) minutes or until the acid stops bubbling.
5. Safely dispose of the solution; pouring it into the pool is recommended.
6. Remove the cap and rinse the cell with light water pressure; re-inspect the cell and repeat acid cleaning if the cell is still scaled.

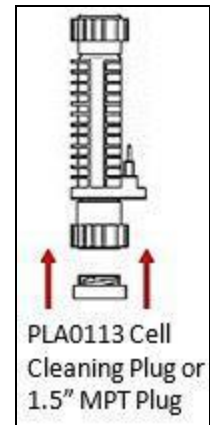

Figure 9

6.3.d Installing

- ⚠ CAUTION** - Failure to heed the following may result in equipment damage.
- The Digital Nano system is to be used **ONLY** with an PPC1 cell. Use of any other cell may cause equipment damage and void warranty.
 - The Digital Nano+ system can be used with the larger PPC2 or the smaller PPC1 cell (it is normally shipped with the PPC2 cell).

- ⚠ CAUTION** - Failure to heed the following may result in equipment damage.
- The electrical terminals must be completely dry to avoid corrosion and failure of the cell or cable.
 - Ensure that the cell cable is fully engaged. A partially seated cable may result in damage to the cable or cell during operation.
1. Clean and dry the electrical pins on the cell. The contacts must be completely dry to avoid corrosion and failure of the cell or cable.
 2. Ensure the union o-rings are in place; then place the cell into the manifold with cell pins pointed upward. See Figure 7.
 3. If necessary, use water to rinse away any dirt and debris on the union and then tighten the unions by hand for a watertight seal. The cell cable has three (3) electrical contact pins. The cell will have two (2) electrical pins. Position the cell plug so the two (2) open holes align with two mating terminals and push gently, but firmly, to connect. Use the red weather plug (supplied) to seal the unused contact in the cable.
 4. Turn on the system.
 5. Check for leaks and proper operation.

6.4 Winterizing

⚠ CAUTION - Failure to heed the following may result in equipment damage.

- Special measures are required in the event of freezing conditions. The Pool Pilot® may be damaged if measures are not taken in advance of freezing conditions. Equipment damage due to freezing conditions is NOT covered under the equipment warranty.

During brief freezing conditions, allow the filtration system to run continuously throughout the freeze period. Circulating (moving) water will not freeze.

In areas where freezing conditions are prevalent and sustained, the equipment must be winterized as follows:

6.4.a Control Unit and Manifold Assembly

- Drain all water from the manifold assembly (cell and Tri-sensor), pump, filter, supply and return lines prior to freezing weather.
- If desired, AutoPilot® plug kit #996 may be purchased to cover the openings. The manifold assembly, including the cell, Tri-sensor and cables may be stored indoors.
- The control unit is not affected by the cold and does not need to be removed.



Figure 10

6.5 Spring Start Up

It is recommended the water be manually chlorine-shocked when first starting up the pool in the springtime. Test water, and add the appropriate chemicals to balance the pool water per the levels recommended in this manual. See "Water Balance and Chemistry Recommendations" on page 6. Be sure to check salt and Cyanuric acid (stabilizer), bringing those readings up to the recommended levels. It is also a good idea to inspect the cell, manifold screen, and test the Tri-sensor flow switch; clean and/or replace those items as necessary. See "Removing / Inspecting / Cleaning Tri-sensor" on page 13. See "Servicing the Cell" on page 15.

SECTION 7 - PROGRAMMING

7.1 Control Panel

7.1.a Button Overview

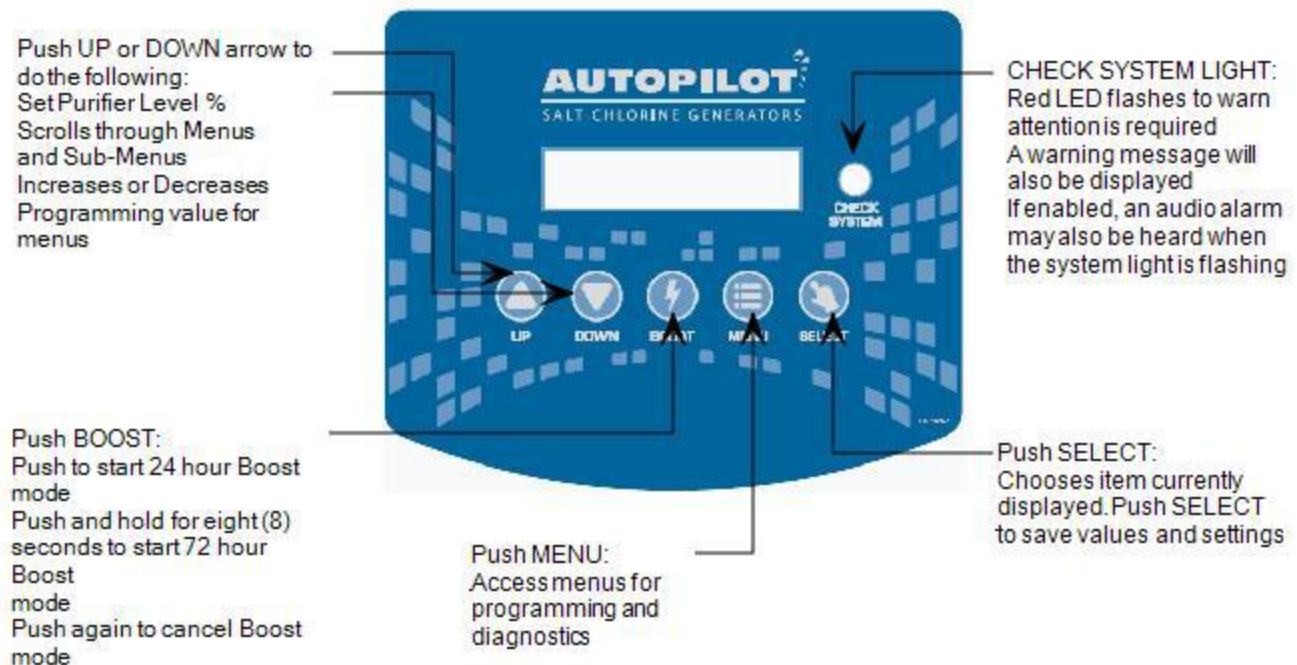

7.1.b MENU / SELECT Button

The MENU button is used to enter the program and diagnostic modes. Use the UP/DOWN arrows and SELECT button to navigate through the menus and sub-menus.

Note: To permit quick access to features, some functions are accessed or programmed in several menus.

- Test Pool Pilot - displays various operating parameters and diagnostic results.
- View Setup - displays the programmed setup parameters.
- Owner Options - programs the primary operating parameters an owner would need to change.
- Maintenance Menu - tests and programs the primary features a service technician would need to access when servicing the system.
- Installer Menu - program the initial system setup.

SELECT Button

The SELECT button chooses the displayed menu option. For the “Installer Menu”, press and hold the SELECT button for approximately 13 seconds to access this feature. The SELECT button also temporarily disables the alarm during an error display.

7.1.c Display Overview

The first line of the display typically indicates purifier/chlorine output level in percent (%), or whether the system is in Boost or Super-Boost mode. The second line will show the following information:

- If Temperature Display is turned on, the temperature in either °F or °C will be shown.
- “On” in the lower right corner will indicate whether the cell is generating chlorine.

7.2 Menus

Use this overview for quick reference to the menu program sequence. Some menu features will only display with specific system configurations, as noted below.

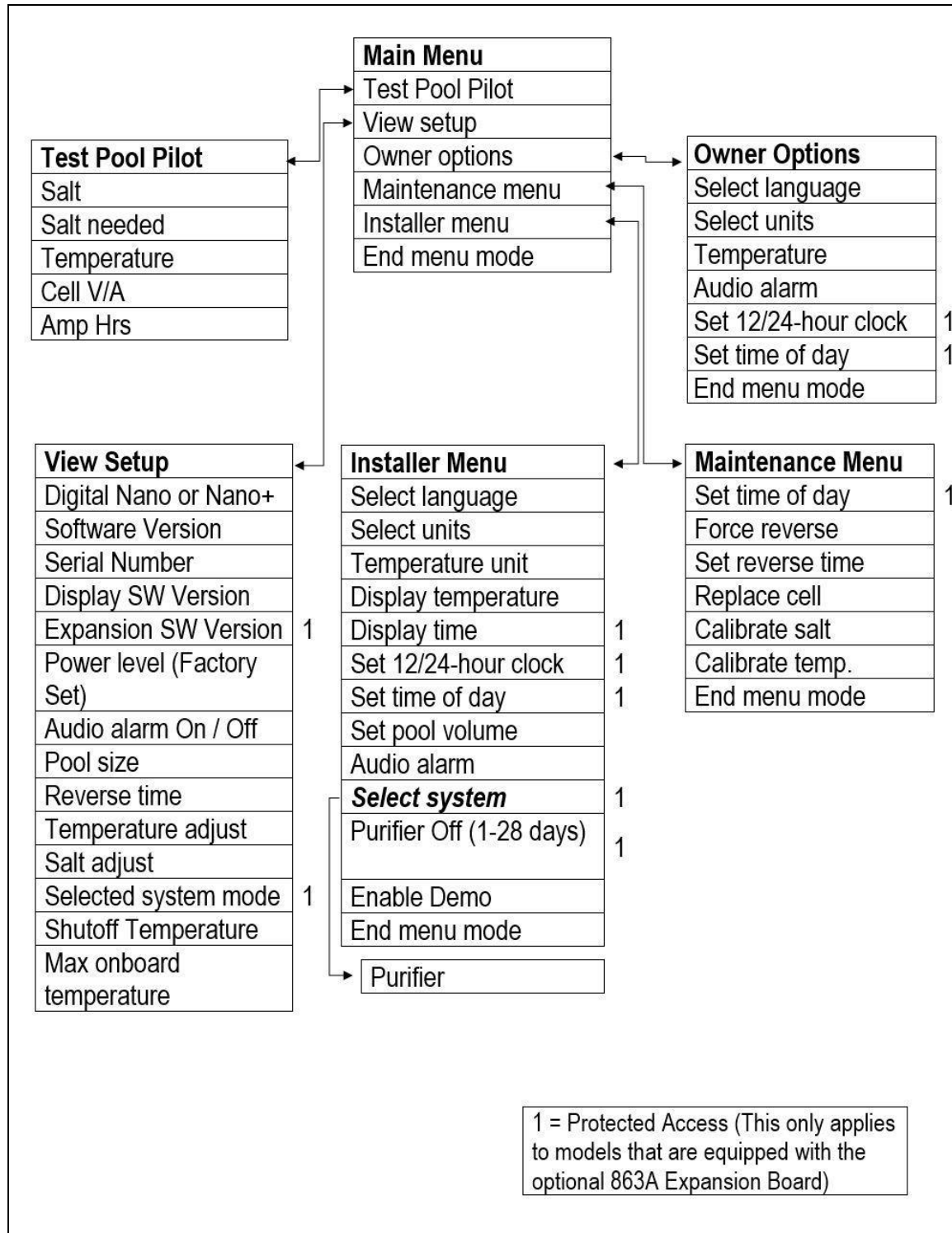

7.3 Basic Operational Programming

7.3.a Adjusting the Purifier Output %

Typically, once the initial setting is established, very little adjustment is needed. The Purifier Output % setting refers to the amount of time the cell is energized within a fifteen (15) minute cycle. The system cycles on-and-off, as indicated on the display's lower right display and "On" when generating chlorine. Higher settings will generate more chlorine.

1. Press the UP or DOWN arrow buttons to enter the purifier adjustment mode.
2. Use the UP or DOWN arrow buttons to adjust the purifier/chlorine output percentage to the desired output: from 0% (off) to 100 % ; then press SELECT to save the new output value and default back to the normal display. At start up of a new system, the standard output setting starting point is 50%.

50% setting = 50% of 15 minutes or 7.5 minutes ON and 7.5 minutes OFF.

25% setting = 3.75 min ON, 11.25 min OFF

Once the percentage is set, the unit will implement the temperature compensation algorithm based on current water temperature.

7.3.b Boost or Super Boost

The Boost feature is used to increase the purifier % from its normal setting to 100% for a cumulative 24 hour or 72 hour period. When the Boost period expires or is manually terminated, the purifier % returns to its previous setting and normal operation.

- Boost purifier output to 100% for 24 hours: From the normal operation mode, press and release the BOOST button. The display will flash: "Boost 24 hour on", then "Boost hh" (with the "hh" actually being the displayed hours remaining in the boost period).
- Boost purifier output to 100% for 72 hours: From normal operation mode, press and hold the BOOST button until: "Boost 72 hour on" is displayed; then release the BOOST button. Display will show: "Boost" for approximately 8 seconds, after that: "Boost 72 hour on" will display; then, "Boost hh" (with the "hh" actually being the displayed hours remaining in Boost period).
- If an external time clock or controller turns off power to the Pool Pilot® while Boost is active, the Boost timer is stored in memory and the Boost time countdown will resume when power is reapplied to the unit.
- If water flow is stopped during a Boost cycle, chlorine generation will stop while there is no flow but the Boost timer will continue to count down as long as the Pool Pilot® has power.

Caution: Regardless of retractable pool cover position, when the Boost feature is activated the unit will increase chlorine production to 100% for 24 or 72 hours based on the Boost time selected.

To exit Boost or Super Boost mode and revert to normal operation:

- Allow the Boost cycle to expire, or
- Press BOOST at any time to manually deactivate Boost.

7.3.c Purifier Mode

The Pool Pilot® will automatically display informative messages about the condition of the unit (purifier output %, water temperature, warning messages, etc.), and responds to manual adjustment of purifier % setting (as described below). The unit will revert to the normal display if there is no activity on the keypad for thirteen (13) or more seconds.

7.3.d Purifier % Adjustment Procedure

1. Balance water chemistry according to necessary water chemistry parameters. See "Basic Water Chemistry" on page 44. For new start ups, if free chlorine level as tested is not at least 1 ppm (mg/L), add liquid chlorine to ensure 1 to 3 ppm (mg/L) free chlorine reading.
2. Add the proper amount of salt as indicated on the display (or as described on page 48), and run the circulation pump continuously for 24 hours, allowing the salt to be fully mixed and dissolved into the pool. If the salt level is too low, the Pool Pilot® will provide a warning and will not generate chlorine until the minimum salt level has been reached.
3. Use the UP and DOWN arrow buttons to set the purifier to 50% and then allow the pool to operate normally. If the pool cover is closed, adjust purifier to 10% rather than 50%.

For the first two weeks, test the water chemistry parameters every 3-4 days. Adjust chemicals as needed to maintain correct water balance.

For the Free Chlorine adjustment, use the following table for fine-tuning the controller output percentage (%):

Table 5

PURIFIER % CURRENTLY SET TO:	IF FREE CHLORINE IS LOWER THAN IDEAL RANGE...	IF FREE CHLORINE IS HIGHER THAN IDEAL RANGE...
1% - 25%	The purifier output % needs to be increased.	The purifier output % setting is too high.
	Use the UP arrow button to increase the purifier output %. Press SELECT to lock in change.	Use the DOWN arrow button to lower output. Press SELECT to lock in change. The free chlorine will need to be tested frequently and the purifier % output will need to be adjusted as needed to attain desired level.
25% - 99%	The purifier % output needs to be increased.	The purifier output % needs to be decreased.
	Use the UP arrow button to increase the purifier output %. Press SELECT to lock in change.	Use the DOWN arrow button to decrease the purifier output %. Press SELECT to lock in change.

After the optimal output percentage (%) has been determined, this setting will not normally require further adjustment. Select a Boost cycle to compensate for increased bather usage or heavy rainfalls (which can both quickly consume chlorine).

7.4 Test Pool Pilot (Diagnostic Menu)

Press the MENU button, then press the UP or DOWN arrow until "Test Pool Pilot" is displayed, and press the SELECT button. The display will automatically sequence through the following displays and then return to normal operation. You can also press the UP or DOWN arrow to scroll forwards and backwards. Press the MENU button again to skip the remaining displays and exit back to normal operation. The following information is displayed:

- "Salt = ##### ppm (#.# g/L)" (The optimum salt level is 3,000 ppm (mg/L), 4,500 ppm (mg/L) for increased chlorine production)
- "Add Salt ## lbs (## Kg)" (The amount of salt needed to maintain 3,000 ppm (mg/L))
- "Temperature ##° F (##° C)" (The temperature of the water flowing through the Tri-sensor)
- "Cell = ## V #.# A" (The measured voltage and current sent to the cell)
- "Amp-Hrs = #####" (The amount of current times hours of operation received by the cell)

7.5 View Setup

A program and parameter menu used to view the currently programmed settings.

Press the MENU button, then press UP or DOWN arrow until "View Set Up" is displayed and press the SELECT button. The display will automatically sequence through the following displays and then return to normal operation. You can also press the UP or DOWN arrow to scroll forwards and backwards. Press the MENU button again to skip the remaining displays and exit back to normal operation. The following information is displayed:

- "Nano" or "Nano+"
- "Software V #" (The version number of Main Board software)
- "Serial #" (The Pool Pilot® serial number)
- "Display V #" (The version number of Display Board software)
- "Expansion V#" (The version number of the Expansion Board software)
- "Power level" (The amperage driven to the cell. Set by the factory to 5A)
- "Audio alarm On / Off" (Set by the factory to Off)
- "##, ### gallons (liters)" (The pool volume programmed in Installation Menu; 15,000 gallons (60,000 liters) is the factory setting)
- "Reverse = # hrs." (The reverse rate programmed in Installation Menu: 4 hrs. is factory setting)
- "Temp. adjust = #" (The temperature adjustment variation of actual Tri-sensor reading)
- "Salt adjust + #" (The salt calibration adjustment variation of actual Tri-sensor reading)
- "Purifier", "pH Control", "Total Control" (The system mode selected. Purifier is the factory setting)
- "Shutoff Temp" (Internal temperature of the unit at which it goes into a 5 minute cool-down period)
- "Max temp" (Maximum internal temperature reached)

7.6 Review Of Installer, Owner, & Maintenance Menu Programming

Note: Once programmed for the installation site, the following menu items should not require regular access. See "Basic Operational Programming" on page 20.

7.6.a Set Pool Volume

The pool volume must be programmed for the "Add salt ### lb (kg)" display to be accurate. See "Calculating Pool Volume" on page 35.

1. Press MENU, press Δ or ∇ until "Installer menu" is displayed, then press and hold SELECT for 13 seconds.
2. Press Δ or ∇ until "Set pool volume" is displayed, then press SELECT.
3. Factory setting is 15,000 gallons (60,000 Liters). The range is 500 to 125,000 gallons (2,000 to 500,000 Liters).
4. Press Δ or ∇ until correct pool size is displayed, then press SELECT.
5. Press Δ or ∇ until "End menu mode" is displayed, then press SELECT.

7.6.b Calibrate Salt

Note: The unit has been calibrated at the factory and should not require further adjustments. In the event the salt display does not match on-site test results, follow these steps (it is necessary to wait two (2) minutes after water flow has started before calibrating salt):

1. Press MENU, press Δ or ∇ until "Maintenance Menu" is displayed, then press SELECT.
2. Press Δ or ∇ until "Calibrate salt" is displayed, then press SELECT.
3. Press Δ or ∇ until the number on the display matches the accurately measured pool sample, then press SELECT. The maximum adjustment is $\pm 1,000$ ppm (mg/L).
4. Press Δ or ∇ until "End menu mode" is displayed, then press SELECT.

7.6.c Select Language

Allow for personal preference language display.

1. Press MENU, press Δ or ∇ until "Owner options" or "Installer menu" is displayed, then press SELECT.
2. Press Δ or ∇ until "Select language" is displayed, then press SELECT (English is the factory setting).
3. Press Δ or ∇ until desired option "English language" "Idioma Español", "Langue Francaise," "Deutsche sprache", "Lingua Italiana" or "Cesky Jazyk" is displayed, then press SELECT.
4. Press Δ or ∇ until "End menu mode" is displayed, then press SELECT.

7.6.d Calibrate Temperature

Note: You must wait a full two (2) minutes after start up to calibrate temperature. Used only when it is desired to match the display of the Pool Pilot® to another on-site thermometer.

1. Press MENU, press Δ or ∇ until "Maintenance menu" is displayed, then press SELECT.
2. Press Δ or ∇ until "Calibrate temp" is displayed, then press SELECT.
3. Press Δ or ∇ to adjust temperature UP or DOWN to the desired setting, then press SELECT. The maximum adjustment is $\pm 6^{\circ}$ F ($\pm 3^{\circ}$ C).
4. Press Δ or ∇ until "End menu mode" is displayed, then press SELECT.

7.6.e Select Units

Used to program the operator's personal preferences for the liquid and weight measurements the Pool Pilot® will display.

1. Press MENU, press Δ or ∇ until "Owner options" or "Installer menu" is displayed, then press SELECT.
2. Press Δ or ∇ until "Select units" is displayed, then press SELECT ("English units" is the factory setting).
3. Press Δ or ∇ until desired measurement "English units" (gallons and pounds), or "Metric units" (liters and kilograms), is displayed and then press SELECT.
4. Press Δ or ∇ until "End menu mode" is displayed, then press SELECT.

7.6.f Set Temperature Unit

Set personal preference for temperature display units ($^{\circ}$ C or $^{\circ}$ F).

1. Press MENU, press Δ or ∇ until "Owner options" or "Installer menu" is displayed, then press SELECT.
2. Press Δ or ∇ until "Temperature unit" is displayed, then press SELECT (Fahrenheit is the factory setting).
3. Press Δ or ∇ until desired measurement unit "Fahrenheit" or "Celsius" is displayed, then press SELECT.
4. Press Δ or ∇ until "End menu mode" is displayed, then press SELECT.

7.6.g Display Temperature

Choose to either show or hide the water temperature on the normal display screen.

1. Press MENU, press Δ or ∇ until "Installer menu" is displayed, then press and hold SELECT (approximately 13 seconds) until "Installer menu" is displayed again and is accessible.
2. Press Δ or ∇ until "Display temp" is displayed, then press SELECT. ("Show temperature" is the factory setting.)
3. Press Δ or ∇ until "Show temperature" or "Hide temperature" is displayed. Choose desired option and then press SELECT.
4. Press Δ or ∇ until "End menu mode" is displayed, then press SELECT.

Note that even if the Display Temp feature is turned off, the temperature can be viewed in the "Test Pool Pilot" menu for diagnostic purposes.

7.6.h Set Reverse Time

Program cell's self-cleaning cycle.

 CAUTION - Failure to heed the following may result in equipment damage.

- Reduced polarity reversing cycle times will reduce cell life and should only be used due to uncontrollable scale formation on the cell. Always test and adjust water balance before attempting scale control via shortening reverse period. See "Using the Saturation Index" on page 47.
1. Press MENU, press Δ or ∇ until "Maintenance menu" is displayed, then press SELECT.
 2. Press Δ or ∇ until "Set reverse time" is displayed, then press SELECT (4 hours is the factory setting).
 3. Press Δ or ∇ until the desired cycle time (2, 4, 8, or 16 hours) is displayed, then press SELECT.
 4. Press Δ or ∇ until "End menu mode" is displayed, then press SELECT.

7.6.i Force Reverse

Note: This is a diagnostic tool only and should not be used unless a problem is suspected.

Program the cell to activate a Force Reverse cycle and verify if the system is reversing polarity (self-cleaning). There will be a forty (40) second delay after selecting "End menu mode", before reversing takes place.

1. Press MENU, press Δ or ∇ until "Maintenance menu" is displayed, then press SELECT.
2. Press Δ or ∇ until "Force reverse" is displayed, then press SELECT.
3. "Cell reversing" will display temporarily in forty (40) seconds.
4. Press Δ or ∇ until "End menu mode" is displayed, then press SELECT.
5. The "." (period) on the end of second line of the display will either appear or disappear, based on its previous state, to indicate cell power polarity has reversed.

7.6.j Enable / Disable Audio Alarm

Note: If alarm is due to low or no water flow, the Audio Alarm will automatically silence in ten (10) minutes. Upon restoration of flow, normal Audio Alarm operation will resume.

1. Press MENU, press Δ or ∇ until "Owner options" or "Installer menu" is displayed, then press SELECT.
2. Press Δ or ∇ until "Audio alarm" is displayed, then press SELECT.
3. Press Δ or ∇ until "On or Off" is displayed, then press SELECT.
4. Press Δ or ∇ until "End menu mode" is displayed, then press SELECT.

7.7 Menu Programming-Optional 863A Expansion Board Features

7.7.a Display time

Choose to either show or hide the time on the normal display screen.

1. Press MENU, press Δ or ∇ or until "Installer menu" is displayed, then press and hold SELECT (approximately thirteen (13) seconds) until "Installer menu" is displayed again and is accessible.
2. Press Δ or ∇ or until "Display time" is displayed, then press SELECT. ("Hide" is the factory setting.)
3. Press Δ or ∇ or until "Show time" or "Hide time" is displayed. Choose desired option and then press SELECT.
4. Press Δ or ∇ or until "End menu mode" is displayed, then press SELECT.

7.7.b Set 12/24 Hour Clock

Set personal preference for time clock display.

1. Press MENU, press Δ or ∇ until "Owner options" or "Installer Menu" is displayed, then press SELECT.
2. Press Δ or ∇ until "12/24 hour clock" is displayed, then press SELECT (12 hour is the factory setting).
3. Press Δ or ∇ until desired time format "12 hour" or "24 hour" is displayed, then press SELECT.
4. Press Δ or ∇ until "End menu mode" is displayed then press SELECT.

7.7.c Set Time of Day

Change the time of day display to correct for time zone or day-light savings.

1. Press MENU, press Δ or ∇ until "Owner options", "Maintenance Menu" or "Installer Menu" is displayed, then press SELECT.
2. Press Δ or ∇ until "Set time of day" is displayed, then press SELECT (Eastern Standard Time is the factory setting).
3. Press Δ or ∇ until the desired hour is displayed, then press SELECT.
4. Press Δ or ∇ or until the desired minutes are displayed, then press SELECT.
5. Press Δ or ∇ or until "End menu mode" is displayed, then press SELECT.

7.7.d Select System

Used by the installer to set the basic equipment configuration of the system.

1. Press MENU, press Δ or ∇ until "Installer menu" is displayed, then press and hold SELECT for thirteen (13) seconds.
2. Press Δ or ∇ until "Select system" is displayed, then press SELECT (Purifier is the factory setting). The display will show the current configuration.
3. Press Δ or ∇ until "Purifier" is displayed, then press SELECT.
4. Press Δ or ∇ until "End menu mode" is displayed, then press SELECT.

If the optional 863A Expansion Board has been installed, additional options will be displayed that are not supported with this model. **Do not** choose "pH Timed", "pH Probe" or "Total Control".

NOTE: Make sure that Select System is always set to Purifier.

7.7.e Set Purifier Off

The Digital Nano / Nano+ system can be programmed to delay chlorine production if salt will not be added to the pool water for a specified amount of time, from 1-28 days. The system will automatically start up in the Purifier mode after the user defined time has expired. This feature can be used when starting up a newly constructed or resurfaced pool when salt is not going to be added for a few days. The unit will display normal operating messages, including salt levels, but will not show error messages related to chlorine production or salt levels.

1. Press MENU, press Δ or ∇ until "Installer menu" is displayed, then press and hold SELECT for approximately thirteen (13) seconds to enter the Installer menu.
2. Press Δ or ∇ until "Purifier Off" is displayed, then press SELECT.
3. Press Δ or ∇ until the desired amount of days "## Day(s)" is displayed and then press SELECT.
4. The display will flash "Purifier Off; ## Day(s)" three times and then display the next menu option.
5. Press Δ or ∇ until "End menu mode" is displayed, then press SELECT.

The system will now begin to count down and will not generate chlorine until the amount of time chosen has expired.

To turn this feature off before the designated time has elapsed:

1. Press MENU, press Δ or ∇ until "Installer menu" is displayed, then press and hold SELECT for approximately thirteen (13) seconds to enter the Installer menu.
2. Press Δ or ∇ until "Purifier Off" is displayed, then press SELECT.
3. The days remaining will be displayed. Press Δ or ∇ until "0 Day(s)" appears, then press SELECT.
4. Press Δ or ∇ until "End menu mode" is displayed, then press SELECT.

SECTION 8 - INSTALLATION

8.1 Basic System Overview

The Pool Pilot® salt chlorination system is designed to operate in the following configurations:
Shown with automatic-flow bypass manifold assembly (models PPM1 and PPM2):

Figure 11

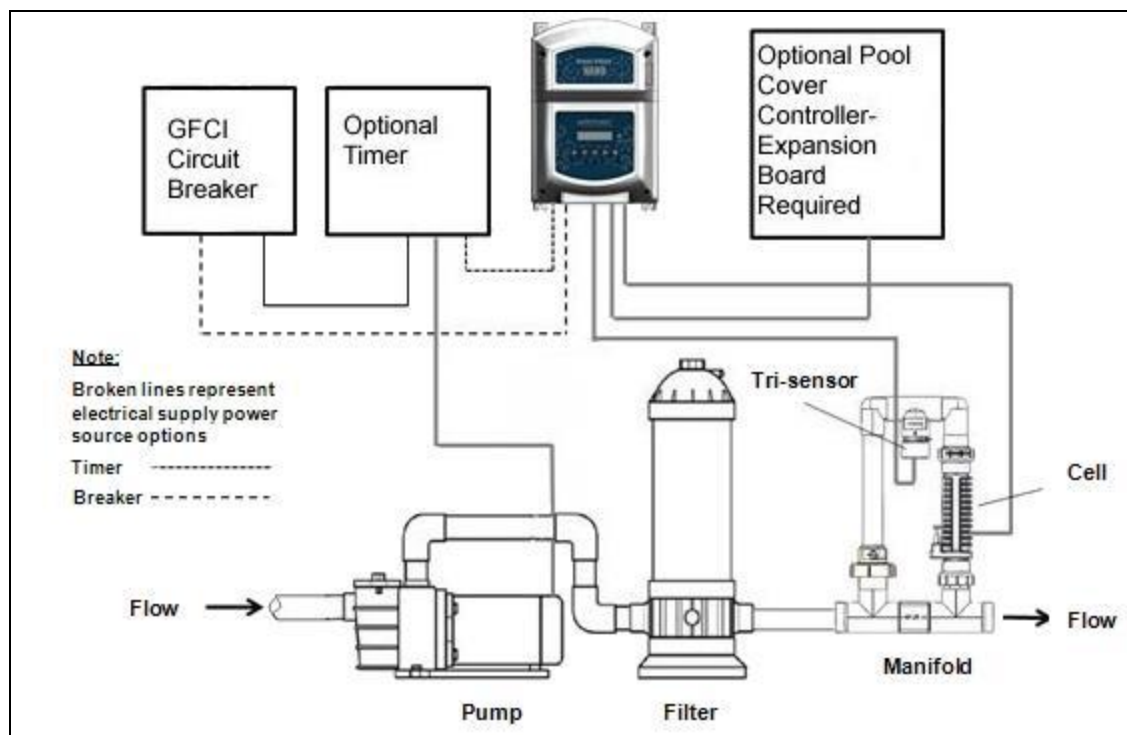

Shown with optional CoPilot® and CoPilot® manifold assembly (models PPM1 and PPM2):

Figure 12

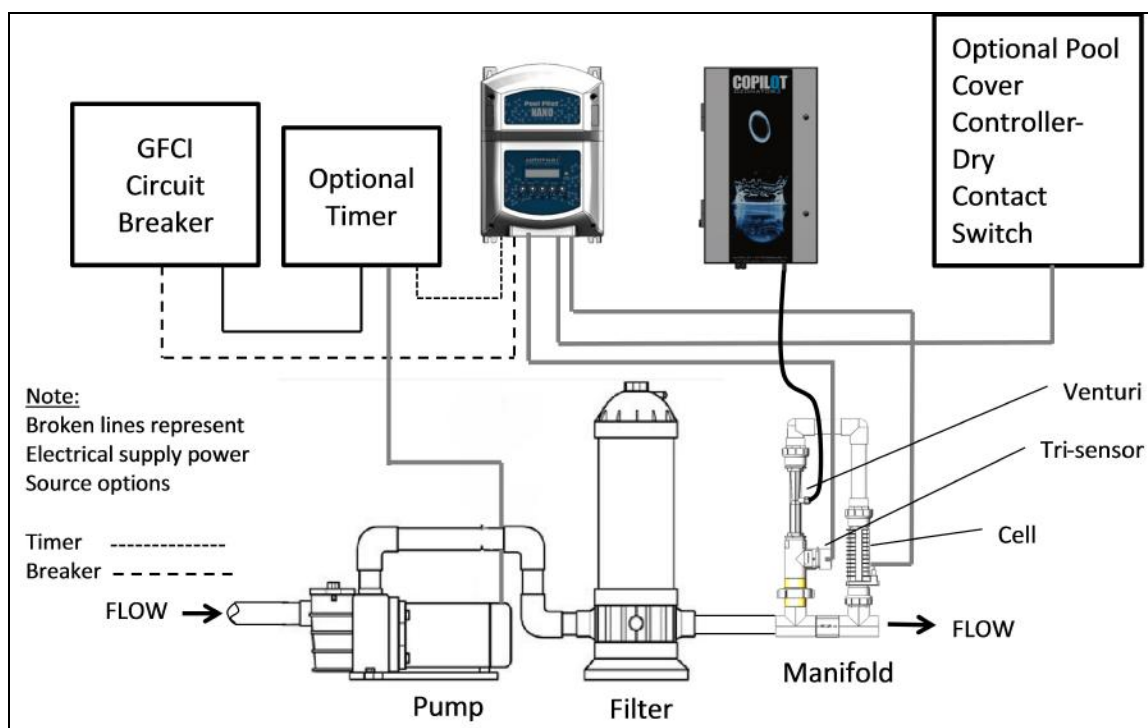

8.2 Planning the Installation

Before installing your Pool Pilot®:

1. Determine everything needed for installation is on hand.
2. Determine where the manifold assembly will be plumbed.
3. Identify a suitable mounting location for the Pool Pilot® close enough, less than 12' (3.6 m), to ensure that the cell cord and Tri-sensor cord will reach the manifold components. Plan the routing for the cell and Tri-sensor cables.
4. For the optional retractable pool cover installations with the Digital Nano / Nano+ models (the 863A Expansion Board must be purchased and installed):
 - a. Procure / install dry contact cover position switch or retractable cover controller as needed.
 - b. Plan cable (not provided) run from cover position switch to Digital Nano / Nano+.
5. Determine whether the input voltage for the Pool Pilot® will be 110-120 Vac or 220-240 Vac.
6. Plan wire runs and wiring connections for source power.
7. Determine origination point for the Pool Pilot® control unit power feed:
 - a. Directly from a circuit breaker. (Circuit breaker is used to power the Pool Pilot® and circulation pump.)
 - b. From an external timer or an electronic controller. (Pool Pilot® is to be wired to the same location as the circulation pump; the Pool Pilot® is activated when the circulation pump is energized.)

8.3 Check Parts

Before attempting the installation, verify the following items have been included with the Pool Pilot®:

QUANTITY	DESCRIPTION
1	220 Vac - 54" (inches / 1.37m) cord for 220V (pre-installed)
1	Strain relief – ½" (220V only) (models 75041A and 75043A) (pre-installed)
1	Split gland – ½" (when equipped with 863A Exp. Board. Comes with optional kit #STK0156)
1	Cell cable
4	Plastic anchors
4	Mounting screws
2	Metric PVC adapters (2" spigot x 63 mm socket) (metric manifold models only)

Table 6

Not included

Power service electrical or bonding wire
Pool cover controller, dry contact pool cover position switch, or associated cable

Table 7

8.4 Installation Steps

Details on each step of the installation process are presented on the following pages:

1. Mounting the Pool Pilot® (See "Mounting the Chlorinator" on page 30.)
2. Electrical Connections (See "Electrical Connections" on page 30.)
 - Electrical Connections Overview
 - AC Input Voltage
 - Low Voltage Wiring
 - Connecting the Cell Cable
 - Connecting the Tri-sensor
 - Installing the Optional 863A Expansion Board
 - Connecting the Retractable Cover Switch (option available with installation of the #863A Expansion Board)
 - Bonding
3. Plumbing the System (See "Plumbing The System" on page 29.)

4. Preparing the Water (See "Preparing the Pool Water" on page 35.)
5. Programming at Installation (See "Programming at Installation" on page 37.)

8.5 Plumbing The System

The Manifold Assembly has 2" PVC slip socket connections. Metric PVC adapters, 2" spigot x 63 mm socket, are provided with metric manifold models that have an "M" suffix, such as PPMxM. The manifold is plumbed into the pool return line after the heater and spa diverter valve, if applicable. See "Basic System Overview" on page 27.

8.5.a Plumbing the Manifold Assembly

Select the location for installing the manifold:

- It is recommended the manifold be planned prior to installation of the Pool Pilot® control unit. The control unit must be installed close enough to the manifold assembly to allow the Tri-sensor and cell cables sufficient slack to enable component service and maintenance. The cables are 12' (3.6 m) long.
- The Bypass Manifold/Cell (model PPMxx) assembly must be installed in a vertical (upright) position. See "Basic System Overview" on page 27. This orientation prevents hazardous gas buildup in the system should the flow switch fail to detect sufficient flow.
- The direction of the water flow through the manifold must be as indicated for the system to operate.
- For a pool/spa combination, the manifold must be located as the last component in the pool return line to avoid over-sanitization of the spa.

Flow Rates 20 – 70 gpm (76 – 265 L/min)

- The manifold can be directly plumbed into the system. See "Basic System Overview" on page 27.
- If the flow rate for the system is less than 20 gpm (76 L/min), a larger pump must be installed (or steps taken to improve flow rate).
- For a two-speed or a variable speed pump, ensure the pump can provide sufficient flow at the low speed.

Flow Rates Exceeding 70 gpm (265 L/min)

- A bypass must be installed on systems with flow rates exceeding 70 gpm (265 L/min).

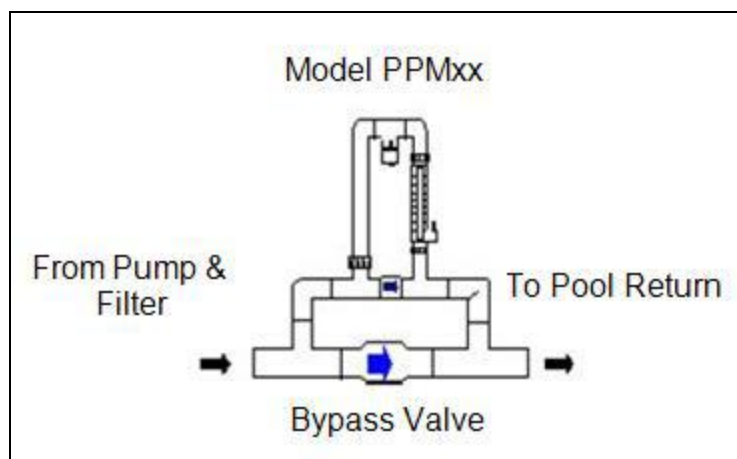

Figure 13

8.6 Mounting the Chlorinator

ATTENTION: To ensure adequate cable length, we recommend plumbing the manifold first and then mounting the control unit close enough so that the cables will reach. The Tri-sensor and cell cables are 12 ft (3.6 m) long. The selected location should allow easy access for service and maintenance.

- ⚠ WARNING** - Failure to heed the following may result in permanent injury or death.
- All electrical connections should be made by a licensed electrician or certified electrical contractor.
 - Ensure electrical power is disconnected before wiring the unit. Follow all state/local NEC (CEC if applicable) electrical codes. Use copper conductors, only.

The Pool Pilot® is suitable for indoor or outdoor mounting. When connected to 230 Vac, the control unit must be installed at least 5 ft (1.5 m) horizontal distance from the pool or spa wall. When connected to 115 Vac, the control unit must be installed at least 10 ft (3 m) horizontal distance from the pool or spa wall. Greater distances may be required by local codes.

The Pool Pilot® control unit is designed to mount vertically on a flat surface with the wiring inputs facing downward. The enclosure is designed to allow heat to dissipate from inside the box. It is important the top or bottom of the enclosure is not blocked.

Do not mount the Pool Pilot® control unit inside a panel or a tightly enclosed area lacking proper and full ventilation.

To avoid damage to wiring and connectors, read the following section before proceeding:

1. Hold the Pool Pilot® chassis level in the selected mounting location. Through the top, narrow portion of the mounting slots, mark the wall for the four (4) mounting holes.
2. Plastic anchors and screws have been provided for concrete or stucco walls; anchors are not required when mounting to wood or composite materials. Drill and install the plastic anchors (as applicable). Tighten the screws into the anchors, temporarily leaving a ¼" (7.0 mm) gap between the wall and the underside of the screw heads.
3. Holding the Pool Pilot® slotted openings to the screw heads, allow the screw heads to pass through the larger portion of the mount holes. Hang the power center on the four (4) mounting screws. Tighten the screws using a long shaft screwdriver.

8.7 Electrical Connections

8.7.a Electrical Connections Overview

- ⚠ CAUTION** - Failure to heed the following may result in equipment damage.
- Connecting 230 Vac to a unit that has been configured to 110-120 Vac will result in permanent damage to the unit. Damage due to incorrect wiring is not covered under the warranty.

- ⚠ WARNING** - Failure to heed the following may result in permanent injury or death.
- Ensure that power is disconnected before wiring this unit.
 - All electrical connections should be made by a licensed electrician or certified electrical contractor.

A high voltage AC input provides power to the control center. Low voltage cables provide power from the Pool Pilot® control center to the Tri-sensor and cell.

The AC input voltage of the Pool Pilot® has been preconfigured at the factory for 230V. This voltage configuration can be changed in the field by a qualified electrician, if required.

Refer to the wiring diagram located on the inside of the power center cover to reconfigure the wires on the terminal block if the unit AC input voltage is going to be changed from 230 Vac to 115 Vac, or see Figure 14 and Figure 15.

Configuring the Power Supply for 110V-120V Operation:

1. Remove the cover by loosening the four recessed Phillips screws in the front corners of the cover.
2. Move the RED wire from the third terminal up to the second terminal.
3. Move the YELLOW wire from the fourth terminal down to the fifth terminal.
4. Install the fuse labeled FUSE: 2A 250V 3AG SLO BLO into the fuse clip on the power supply board as shown in the photo below.

Note: If a 110V cord is needed, you can order the AutoPilot Power Cord Kit #STK0196. You may also obtain a 16 AWG 2 conductor with ground power cord, suitable for outdoor applications, from your local hardware or electrical supply store.

110V - 120V Configuration

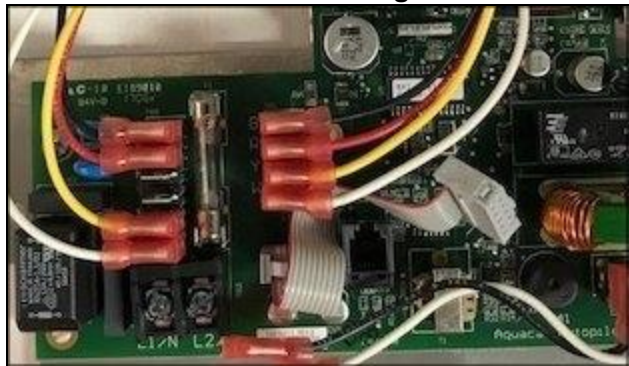

Figure 14

220V - 240V Configuration



Figure 15

8.7.b AC Input Voltage

- ⚠️ **WARNING** - Failure to heed the following may result in permanent injury or death.
 - The Pool Pilot® control center supply circuit must be protected by a ground-fault circuit- interrupter (GFCI).
- ⚠️ **CAUTION** - Failure to heed the following may result in equipment damage.
 - The AC input cannot be provided by an ORP Controller.

The Pool Pilot® control center is typically provided input power either directly from a GFCI breaker or from a timer or controller. Determine which is best for your application. Although not required, ideally the circulation pump and chlorinator are controlled by the same timer.

Connecting to an External Timer or Controller

1. Measure and cut ½" (13 mm) nonmetallic flexible conduit to reach from the power source to the Pool Pilot®.
2. Feed the wires (not supplied) from Pool Pilot® through the conduit.
3. At time clock or external controller relay, connect AC power wiring to the load side or the same location as the circulation pump wires (pump connected to circuit breaker, time clock or electronic controller).
4. Connect the ground wire to the ground of the power source.

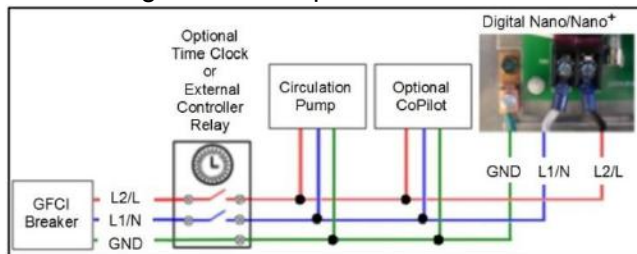

Figure 16

8.7.c Low Voltage Wiring

⚠ WARNING - Failure to heed the following may result in permanent injury or death.

- ELECTRICAL SHOCK HAZARD – Turn off the electrical power to unit before servicing.

Connecting the Cell Cable

1. The cell cable connector is keyed and must be aligned to connect properly. Line up the cell cord and plug into the cell cord connector located on the bottom right of the Pool Pilot® base plate.
2. The other end of the cell cable is connected to two (2) of the cells electrical terminals. A red weather plug is placed in the unused contact hole.

Connecting the Tri-sensor Cable

The Tri-sensor cable is 12 ft long (3.6 m) and connects the Tri-sensor Assembly to the Pool Pilot®. Connect the white 6-pin connector to the mating receptacle located on the base of the unit.

8.7.d Installing the Optional 863A Expansion Board

1. Remove the cover by loosening the four (4) recessed Phillips screws in the front corners of the cover.
2. Carefully release the RJ11 modular plug at the cover end of the cable that attaches the 841-2C Display Board. See Figure 20. Carefully set the cover aside.

⚠ WARNING - Failure to heed the following may result in permanent injury or death.

- RISK OF ELECTRICAL SHOCK - Disconnect all AC input power before you proceed with the next step.

3. Affix the five (5) 1/4" standoffs to the five (5) Kept Nuts, provided with the STK0156 kit, in the pre-drilled holes at top of the chassis. Do not over tighten.
4. Place the 863A Expansion Board onto the standoffs and secure with five (5) 1/8" pan head screws. See Figure 19.
5. Attach the flat ribbon cables (provided in the STK0156 Kit) to the 863A Expansion Board in two places; JP1 on left and JP2 on right. Be sure the red line is on left side of the ribbon. See Figure 21.
6. Attach the flat ribbon cable from position JP1 on the 863A board to the H1 position on the power supply board. See Figure 21.
7. Attach the second flat ribbon cable from position JP2 on 863A board to the H4 position located on the Interface Board. See Figure 21.
8. Locate the terminal on the power supply board that has four (4) male connectors. Remove the existing black and white wires from these terminals only. See Figure 20. They will be the top and bottom positions.
9. Using power cable ECA0348 provided in the STK0156 Kit, attach the multi-stack connectors as shown in Figure 22 (top and bottom positions).
10. Reattach the black and white wires, removed in step 8, to the multi-stack male terminals. Connections will go to the upper and lower male terminals. See Figure 23.
11. Attach the remaining ends from ECA0348 to the power terminals on the left side of the 863A Expansion Board. Note: Black wire on top and White on the bottom. See Figure 24.



Figure 17



Figure 18

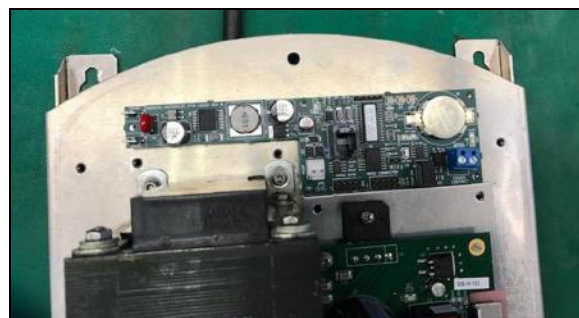

Figure 19

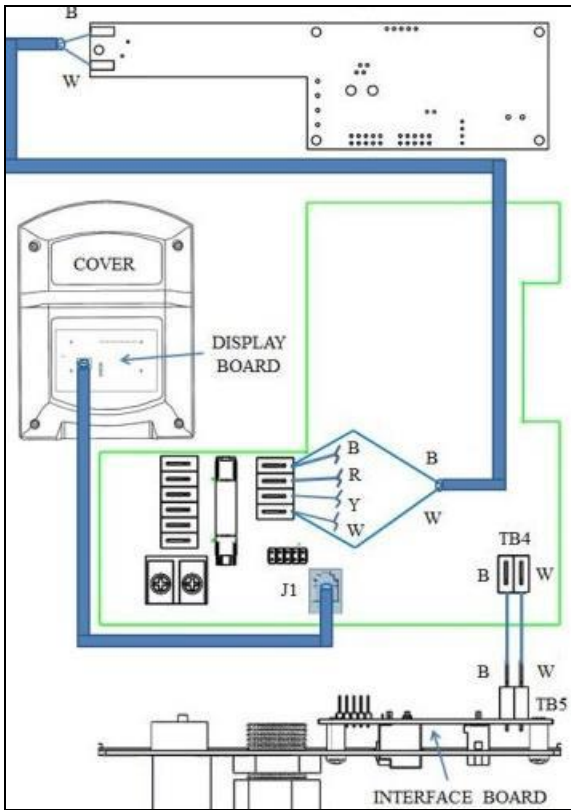

Figure 20

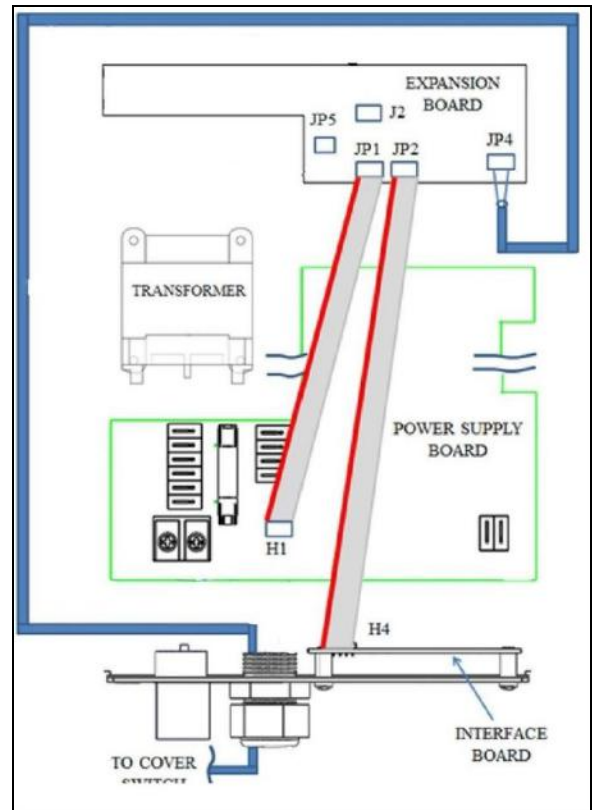

Figure 21

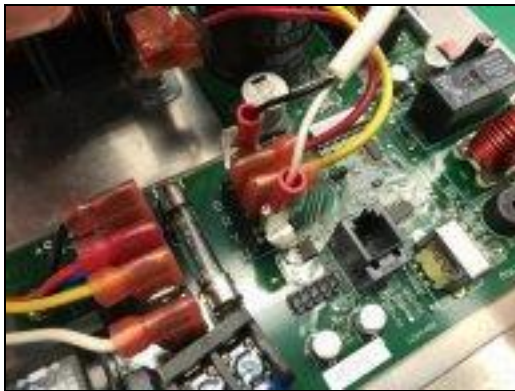

Figure 22



Figure 23

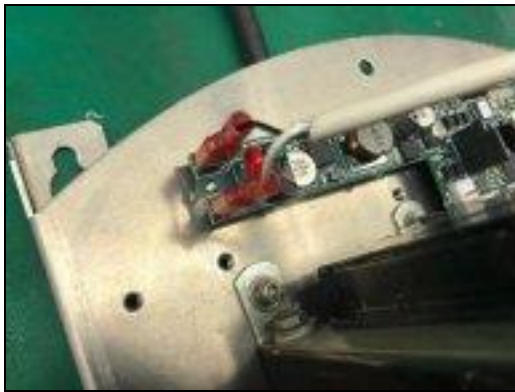

Figure 24

8.7.e Connecting the Retractable Cover Switch (Option only available with purchase of #863A Expansion Board)

- ⚠ CAUTION** - Failure to heed the following may result in equipment damage.
- The cover switch input must connect to an isolated dry contact output from the retractable cover unit. Connection to an energized switch will damage the Digital Nano/Nano+.
 - The contact may not be shared by any other device.
- ⚠ WARNING** - Failure to heed the following may result in permanent injury or death.
- **RISK OF ELECTRICAL SHOCK** - Disconnect all AC input power before you proceed with the next step.
1. Installation will require:
 - a. Two conductor insulated cable 20 AWG, similar to Alpha Wire number 6642 (not supplied).
 - b. External dry contact switch (provided by installer or retractable cover controller manufacturer).
 2. Follow steps 1 thru 11 in the section “Installing the Optional 863A Expansion Board”.
 3. Remove the knock out at the bottom of the Nano chassis and install the split gland provided in the STK0156 Kit. Keep the gland loosened for next step. See Figure 25.
 4. Thread the cover switch cable, provided by installer, through the gland as shown in Figure 25 below.
 5. Connect the two (2) conductors of the cable to the terminal labeled COVER CONTACT on the bottom right side of the 863A Expansion Board. See Figure 26.
 6. Reattach the RJ11 modular cable at J2 on the display board, previously released in step 3, back to the J1 position on the main board. See Figure 20.
- ⚠ CAUTION** - Failure to heed the following may result in equipment damage.
- Do not connect the RJ11 cable to the 863A Expansion Board.



Figure 25



Figure 26

8.7.f Bonding

The Pool Pilot® chlorinator must also be connected to the pool/spa bonding system with an 8 AWG (6 AWG for Canada) wire. A bonding lug is provided at the bottom exterior of the control center.

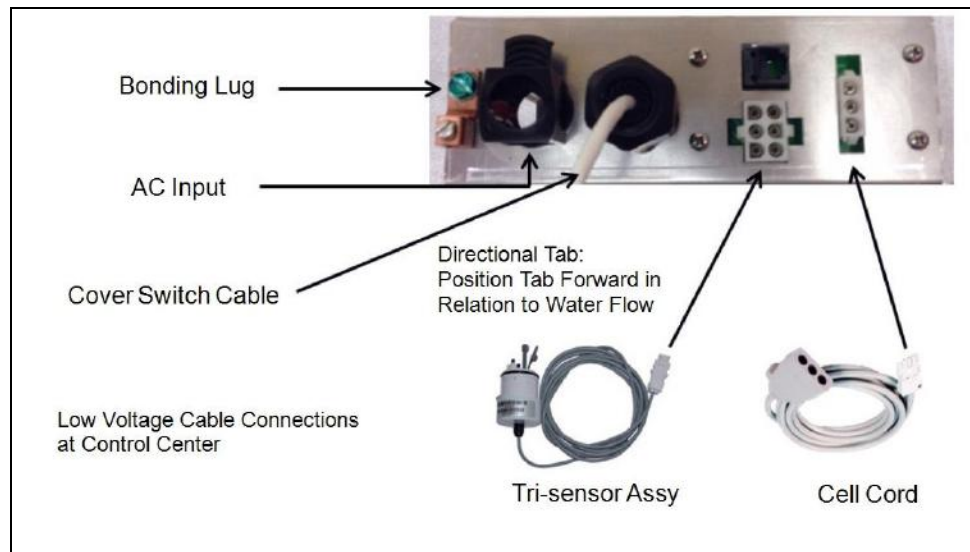

Figure 27

8.8 Preparing the Pool Water

Installer please note - When properly sized to the site, the Pool Pilot® will meet the sanitizer "maintenance" requirements of the pool/spa. The Pool Pilot® is not designed to chlorine shock treat or build up a chlorine residual when starting with a zero or very low chlorine level.

Before starting the chlorinator, the water must be properly balanced and the chlorine level adjusted to between 1 to 3 ppm (mg/L) free chlorine. More on adjusting water balance and start-up chlorine levels follows below.

8.8.a Calculating Pool Volume

To determine the approximate number of gallons or liters in a pool or spa:

1. Determine the surface area.
2. Multiply the surface area by the average depth and the constant conversion factor of 7.5 to convert cubic feet to gallons, or 1,000 to convert from cubic meters to liters.

Rectangle

- Area = Length x Width
- Gallons = area x average depth (ft³) x 7.5
- Liters = area x average depth (m³) x 1,000

Circular

- Area = Radius x Radius x 3.14
- Gallons = area x average depth (ft³) x 7.5
- Liters = area x average depth (m³) x 1,000

To determine the approximate number of gallons or liters in a more complex shaped pool:

1. Divide the complex shape into several simple shapes.
2. Calculate each one separately and then add back together.

Example: An oblong pool can be divided into two radius measurements and one rectangular shape. (R = Radius)

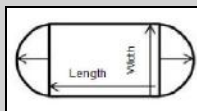

- Area = Radius x Radius x 3.14 + (Length x Width)
- Gallons = area x average depth (ft³) x 7.5
- Liters = area x average depth (m³) x 1,000

8.8.b Steps to Prepare Water

1. Calculate pool volume.
2. Add salt to water (test the water for salt level first). Adjust to 3,000 – 4,500 ppm (mg/L). See "Salt Addition Chart" on page 48.
3. Balance pool water. Add chemicals to adjust pool or spa water chemistry parameters as indicated. See "Water Balance and Chemistry Recommendations" on page 6. See "Using the Saturation Index" on page 47. If the index indicates that the pool water is corrosive or scaling, then adjustments to the water chemistry should be made.
4. Add initial chlorine dosage. Use a sufficient amount of chlorine, as obtained from pool supply center, to achieve 1-3 ppm (mg/L) free chlorine.
5. Enter pool volume information into the chlorinator. See "Set Pool Volume" on page 22.

8.8.c Adding Salt

Type of Salt to Add

It is important to use Sodium Chloride (NaCl) salt that is greater than 99% pure. Acceptable types of salt include granular food grade, pool salt, water softener pellets, or solar salt flakes; these are usually available in 25 to 60 lb bags (11 to 27 kg) at local pool or building supply outlets. Pool salt or food grade granular salt will dissolve faster than pellets or flakes. Rock salt and Granular Salt with Iodine or Rust Preventatives should not be used, as these mixtures contain high levels of impurities that may cause staining. Granular salts containing anti-caking additives such as YPS (Yellow Prussiate of Soda) or sodium ferrocyanide are not recommended as they can cause a localized tint to the water or yellow staining of the pool / spa finish.

Amount of Salt Required

Test the water for current salt content first!

The ideal salt range is 3,000 – 4,500 ppm (mg/L). The minimum salt level is 2,500 ppm (mg/L). However, if so desired, the Pool Pilot® can operate with salt levels in excess of 35,000 ppm (mg/L). Salt levels above 6,000 ppm (mg/L) are not normally recommended, as corrosion issues may result. Salt levels below 2,000 ppm (mg/L) will reduce the efficiency of the Pool Pilot® and result in low chlorine production. Extremely low salt levels below 1,900 ppm (mg/L) will activate the low salt safety cut off and halt chlorine production until salt is replenished to proper levels. Once the Pool Pilot® is programmed to the pool water volume, the controller will automatically indicate how much salt is required to attain ideal salt levels.

For information on amount of salt to be added relative to the volume of water to be treated vs. existing salt level, refer to the "Reference" section in this manual. See "Salt Addition Chart" on page 48.

How to Add Salt to Pool

 CAUTION - Failure to heed the following may result in equipment damage.

- For newly plastered pools, do not use a pool cleaner or vacuum head with wheels, as wheels can leave track marks.
- Do not allow granular salt to pile up in one location without brushing, as staining may occur.

The circulation pump should be run continuously until the salt has been fully dissolved – typically 24 hours. Add salt directly to pool (or spa, if a spa-only installation), and over the main drain (if main drain is present). If there is no main drain, a vacuum head may be used to encourage salt circulation. Distributing the salt by brushing is also helpful; brush the salt toward the main drain (if one is present). Set pump operation to normal run time after salt has fully dissolved into water.

If the salt level becomes undesirably high, the only way to remove excess salt is to partially drain the pool / spa and refill with fresh water.

8.9 Programming at Installation

The Pool Pilot® requires the pool volume be programmed into the installer menu. The Pool Pilot® will then indicate how many pounds (kgs) of salt to add should salt levels fall.

1. Enter the "Installer menu" and program "Set pool volume" for specific pool. See "Calculating Pool Volume" on page 35.
 - a. Press MENU .
 - b. Press Δ or ∇ until "Installer menu" is displayed.
 - c. Press and hold SELECT for 13 seconds to enter the "Installer menu".
 - d. Press Δ or ∇ until "Set pool volume" is displayed, then press SELECT.
 - Factory setting is 15,000 gallons (60,000 liters).
 - The range is 500 to 125,000 gallons (2,000 to 500,000 liters).
 - e. Press Δ or ∇ until correct pool size is displayed; then press SELECT.
 - f. Press Δ or ∇ until "End menu mode" is displayed, then press SELECT.
2. Configure the following as needed. See "Review Of Installer, Owner, & Maintenance Menu Programming" on page 22.
 - "Select language" ("English language", "Idioma Español", "Langue Francaise", "Deutsche Sprache", "Lingua Italiana" or "Cesky Jazyk")
 - "Select units" (gallons / liters, lbs / kgs, ppm / mg/L)
 - "Temperature units" (°F or °C)
 - "Audio alarm" (On or Off)
 - "Display temp" ("Hide temperature" or "Show temperature")
3. Press Δ or ∇ to adjust chlorine output to 50%.

SECTION 9 - TROUBLESHOOTING

9.1 Troubleshooting

Cell inspect due

Problem

This is an advisory message. The unit will generate chlorine normally while this message is displayed.

Typical Solution

This is a reminder to remove and inspect the cell and filter screen to see if they need cleaning. No problem has been detected. This is simply a time elapsed maintenance message. Press and hold SELECT to clear this message.

Cell is cleaning

Problem

This is an advisory message.

Typical Solution

The cell is reversing polarity when this message is displayed. Normal production will resume shortly.

Error purify off / Check flow

Problem

Chlorine generation has stopped due to insufficient water flow.

Typical Solution

1. Turn on the circulation pump.
2. Turn the control valves to the correct position to allow water flow through the manifold.
3. If installed, check suction type vacuum cleaner for blocked or restricted water flow.
4. Check and clean the skimmer basket.
5. Check and clean the pump basket.
6. Check and clean or backwash the main circulation filter.
7. Clean the AutoPilot® manifold screen of trash or debris. For instructions to clean the screen, test the flow switch and clean the bypass valve. Refer to the "Maintenance" section of this manual. See "Test Tri-sensor Flow Switch" on page 14.
8. Verify that the Tri-sensor cable is plugged in. Plug it in, using care to orient it correctly before inserting into the unit.
9. Clean the cell if clogged with debris or calcium scale.
10. Check for air in the bypass manifold by loosening the top union on the cell to see if air or water comes out. If air comes out, there may be a vacuum side leak or the pump may be undersized. Check for a leak at pump basket o-ring, a leaking valve or fitting.
11. If the pump is a 2-speed pump, is it on low speed? The low speed may not create enough flow for the manifold. If using a variable speed pump, increase the RPM.

Error purify off / Add salt xxx lb

Problem

Chlorine generation has stopped because the salt level is below 2,000 ppm (mg/L) (which is too low).

Typical Solution

Add salt as indicated on the chlorinator display to bring the salt level up to 3,000 ppm (mg/L).

Warning! Add salt xxx lb

Problem

The salt level is between 2,000-2,300 ppm (mg/L) (which is low).

Typical Solution

This message will appear when salt is at 2,300 ppm (mg/L) or below. Add salt as indicated on the Pool Pilot® display to bring the salt level up to 3,000 ppm (mg/L).

Error purify off Add salt xxx lb / Warning! Add salt xxx lb

Problem

Added salt as indicated by the chlorinator, but salt level still shows low.

Typical Solution

The pool volume has not been set up in the Installer Menu and is higher than the factory default of 15,000 gallons (60,000 liters).

The salt sensor in the Tri-sensor may be dirty.

The salt display may need to be calibrated. See "Calibrate Salt" on page 22.

Warning! Check / Clean cell

Problem

Conductivity of the water is reduced; usually caused by low salt, cold water, a scaled cell or a combination of other issues.

Typical Solution

Check the salt level and adjust to between 3,000-4,500 ppm (mg/L) or verify salt calibration. For water temperatures below 65°F (18.3°C), increase salt to 3,500 – 4,500 ppm (mg/L). Remove and inspect the cell for white calcium scale. See "Servicing the Cell" on page 15.

Problem

The salt level may be below 2,800 ppm (mg/L) & temperature below 70°F (21°C).

Typical Solution

Increase salt level to 3,500 ppm (mg/L) or increase temperature on heater if applicable.

Problem

The cell may be scaled.

Typical Solution

Water chemistry related problem. See "Basic Water Chemistry" on page 44.

The Pool Pilot® may not be reversing polarity – contact your local AutoPilot Service Center. Adjust water chemistry or adjust Set Reverse time to a shorter cycle.

If this is a new installation...

Verify that the incoming voltage matches the voltage of the Pool Pilot®. See "Specifications" on page 7. See "Electrical Connections" on page 30.

Problem

Cell Amps are low.

Typical Solution

1. Activate Boost, wait 2 minutes and then enter Test Pool Pilot mode through the menu. Write down the salt level, water temperature, and cell volts and amps.
 - If the volts are 24-26, the problem may be caused by low salt, improperly connected, disconnected or loose cell cord, water less than 65 °F (18.3 °C), a scaled cell, or cell near end of life. Correct as appropriate.
 - If the volts are less than 20, contact AquaCal AutoPilot, Inc. for assistance.
2. Installer: If the unit is configured for 230 Vac operation, verify the input AC voltage is not 115 Vac. Supply correct voltages or reconfigure the unit as appropriate.

Warning! Low Amps: Cell?

Problem

Cell may be depleted.

Typical Solution

Check for visual wear on the edges of the terminal blades which may be an indication that the cell is depleted. Replace if depleted.

Problem

The cell cord may be disconnected or damaged.

Typical Solution

Check the cell cord for tight connections on the cell and on the power supply. Tighten as needed.

Check the plug for burns. Replace as needed.

Problem

The cell may be heavily scaled.

Typical Solution

Remove and acid wash. See "Servicing the Cell" on page 15.

Problem

Cell Amps are low.

Typical Solution

1. Activate Boost, wait 2 minutes and then enter Test Pool Pilot mode through the menu. Write down the salt level, water temperature, and cell volts and amps.
 - If the volts are 24-26, then the problem may be caused by low salt, improperly connected, disconnected or loose cell cord, water less than 65 °F (18.3 °C), a scaled cell, or cell near end of life. Correct as appropriate.
 - If the volts are less than 20, then contact AquaCal AutoPilot, Inc. for assistance.
2. Installer: If the unit is configured for 230 Vac operation, then verify the input AC voltage is not 115 Vac. Supply correct voltages or reconfigure the unit as appropriate.

If this is a new installation...

Verify that the incoming voltage matches the voltage of the Pool Pilot®. See "Specifications" on page 7. See "Electrical Connections" on page 30.

See additional troubleshooting on this error later in this section.

Warning! Low cell volts

Problem

There could be a problem with the unit's power control board.

Contact your local AutoPilot® Service Center for assistance.

Warning! Bad temp sensor?

Problem

Temperature is out of range.

Typical Solution

1. Check the Tri-sensor cable; make sure it is not disconnected or loose.
2. Check the water temperature. If confirmed temperature is OK, contact AquaCal AutoPilot, Inc. for assistance.

Warning! Low Amps: Cell? Warning! Low cell volts Warning! No output (All three messages)

Problem

Pool Pilot® control unit problem.

Typical Solution

All three messages must be displayed for this to be a control unit problem. Contact AquaCal AutoPilot, Inc. for service.

If all three messages are not displayed, refer to the specific individual fault message above.

Temperature display shown or not shown

Problem

Temperature is not shown on normal display.

Typical Solution

Normal operation if "Display temp." has been set to "Hide temperature". See "Display Temperature" on page 24.

Note: Temperature will always be visible in the "Test Pool Pilot" menu.

Problem

Does not match other pool temperature displays.

Typical Solution

Normal – This temperature may not match other pool devices due to the sensor location (ie: may be after heater). Disable "Display temp". See "Display Temperature" on page 24.

The temperature display can be disabled in the "Installer menu".

The temperature may be adjusted to match an external thermometer. See "Calibrate Temperature" on page 23.

NOTE: Before calibrating temperature, make sure that there is not a running heater "upstream" from the Pool Pilot®.

Cooling

Problem

Unit is not generating chlorine.

Typical Solution

Internal temperature of unit has exceeded "Shutoff temp", viewable in Setup Menu. Will turn off chlorine generation for five (5) minutes or until temperature decreases. If this is not causing a chlorine shortage, let the unit automatically cool and resume normal operation.

Move the Pool Pilot® to a shaded area if too hot.

Blank display

Problem

The Pool Pilot® display is blank.

Typical Solution

1. If the display is in bright sunlight, then shade the display to read.
2. Verify external time clock has not turned off power to the Pool Pilot®. (Temporarily override the time clock, if desired, to check the Pool Pilot®.)
3. Verify local shut off switch and / or main circuit breaker for the Pool Pilot® is turned on.
4. If power is provided to unit by an external control device, verify power is provided to and from the device.
5. Fuse may be blown. See "Fuse Location and Ratings" on page 12.

No Error Displays

Problem

Salt level on display does not match pool store or salt test strip.

Typical Solution

1. The test may have been faulty or the salt strips may be old or damaged. Have salt level rechecked at local pool store.
2. If the discrepancy is more than 400 ppm (mg/L), calibrate salt. See "Calibrate Salt" on page 22.

Normal Display

Problem

There are no warning messages on the display but the chlorine level is too low. Water quality looks dirty or cloudy.

Typical Solution

1. The chlorine setting has been fine, but a temporary boost of chlorine is needed to adjust for heavy rain or a temporary bather increase. Press the BOOST button to temporarily elevate the chlorine production level to 100% for 24 hrs. Press and hold the BOOST button for 8 seconds if a 72 hour BOOST cycle is desired. The chlorine output will revert to the original setting after 24 hrs.
2. Check water balance. See "Water Balance and Chemistry Recommendations" on page 6. The Cyanuric acid level may be low and the chlorine is being consumed quickly by the UV from the sun.
3. The purifier output needs to be increased.
 - Use the UP arrow key to increase the purifier output setting. Push SELECT to save the change.
 - Increase the pump run time so the Pool Pilot® is generating chlorine for a longer period of time. (Systems are typically sized for a minimum 8 hr. pump run time.)
4. Consult your local pool service professional and test for high phosphate levels. Use a product such as Lo-Chlor® Lo-Phos® to reduce phosphates.
5. If the water temperature is 55 °F (10 °C) or colder, the Pool Pilot® has automatically turned the Purifier output down to 1% to avoid over-chlorination. Bacteria and algae activity is greatly reduced at these temperatures, so this should not be a problem. Hand dose additional chlorine if necessary.
6. Obtain an independent salt reading to check the Pool Pilot® reading. Add salt, if needed, and recalibrate the Pool Pilot® salt display.
7. Check the "Max temp" in the Setup Menu. If higher than the Shutoff temperature, unit may be going into a cooling mode. Shade or relocate unit to an area less affected by direct sunlight or other sources of heat external to the unit.
8. Possible Pool Pilot® fault.
 - Press BOOST. Wait 10 seconds for the unit to start the Boost cycle.
 - Press MENU. Select "Test Pool Pilot"; record the Volts and Amps when displayed. If the Volts are less than 4.0 and the Amps are less than 1.5, contact the factory for assistance.

Problem

There are no warning messages on the display. The chlorine level is too low but the pool water looks fine.

Typical Solution

The test kit reagents or strips may be old or have been exposed to sunlight. Replace the kit or reagents and retest.

There may be too much chlorine in the pool. The chlorine is bleaching the test kit reagents.

- Dilute the water sample with distilled water and retest. Lower the chlorine output setting with the DOWN arrow button if the chlorine level is too high.

Problem

Purifier % fluctuates from adjusted value.

Typical Solution

The AutoPilot® unit has a patented process for automatically increasing and reducing the chlorine output as the temperature of the water fluctuates. It is normal for the % output to increase as the water temperature increases, and to decrease as the water temperature decreases.

9.2 Additional Troubleshooting for Units Equipped with Optional 863A Expansion Board

Normal Display

Problem

Cover is closed. "Cover closed" is not displayed. Chlorine production too high.

Cover is open. "Cover closed" is displayed.

Typical Solution

1. Confirm the installed Pool Pilot® model has the Pool Cover Detection feature. If not, manually reduce chlorine level when cover is closed. (The cover detection option is only available on some models. See "Specifications" on page 7.)
2. Check external cover position switch for proper operation.
3. Check cable/connections from the cover position switch to the Pool Pilot®.

Chlorine display

Problem

Cannot adjust chlorine production above 20% and "Cover closed" is displayed.

Typical Solution

Normal operation if your pool cover is closed. The Pool Pilot® will not allow the chlorine production to go above 20%. This is to avoid over chlorination.

If cover is open, then check the external dry contact cover position switch & cable for proper operation.

Purify off ## Day(s)

Problem

Chlorine generation is off and will start in ## days. This is an advisory message.

Typical Solution

The Purify Off feature has been activated. Refer to the "Menu Programming-Optional 863A Expansion Board Features" section for more information to inactivate this feature. See "Set Purifier Off" on page 26.

SECTION 10 - REFERENCE

10.1 Basic Water Chemistry

The Pool Pilot® is designed to produce chlorine on a daily basis. To monitor the system's efficiency, the water chemistry ranges and a schedule of periodic checks should be followed.

 CAUTION - Failure to heed the following may result in equipment damage.

- Excessively high chlorine levels can cause premature cell depletion and corrosion damage to pool fixtures and equipment.
- Always follow the instructions on the manufacturer's label whenever handling or using chemicals.

Chemical	Ideal Test Schedule	Effect of Low / High Levels	Corrective Actions
Free Chlorine	Weekly	<u>Low free chlorine</u> : Not enough residual chlorine to safely sanitize pool water.	<u>Low free chlorine</u> : Check for combined chlorine level and shock as necessary. Increase chlorine output to maintain a 1-3 ppm (mg/L) residual. Check stabilizer level and add as necessary.
		<u>High free chlorine</u> : Corrosive to metallic fixtures in pool water. Can bleach swimwear and hair or cause premature chlorinator cell depletion.	<u>High free chlorine</u> : Decrease chlorine output. Let chlorine dissipate normally until 1-3 ppm (mg/L) is achieved. In extreme cases, pool water can be diluted with fresh water or a chlorine neutralizer added. (Diluting will reduce salt and CYA. Check and adjust as needed.)
pH	Weekly	<u>Low pH</u> : (acidic) Equipment corrosion, eye / skin irritation, plaster etching, rapid chlorine consumption .	<u>Low pH</u> : Add sodium carbonate or soda ash.
		<u>High pH</u> : (basic) Scale formation, cloudy water, eye/skin irritation, poor chlorine effectiveness.	<u>High pH</u> : Add sulfuric acid, muriatic acid or sodium bisulfate.
Total Alkalinity	Monthly	<u>Low TA</u> : Eye irritation, pH "bounce", stained/etched plaster and metal corrosion.	<u>Low TA</u> : Add sodium bicarbonate.
		<u>High TA</u> : Constant acid demand, difficulty in maintaining pH, and contributes to scale formation or cloudy water conditions.	<u>High TA</u> : Add sulfuric acid, muriatic acid often or sodium bisulfate more frequently until the TA is within an acceptable range.
Calcium Hardness	Monthly	<u>Low CH</u> : Etching of the plaster, equipment corrosion.	<u>Low CH</u> : Add calcium chloride flakes.
		<u>High CH</u> : Scale formation, cloudy water. Rapid buildup of scale may exceed the system's self-cleaning capability and require manual cleaning of the cell.	<u>High CH</u> : Partially drain and refill pool with fresh water to dilute. (Diluting will reduce salt and CYA. Check and adjust as needed.)
Cyanuric Acid (CYA or Stabilizer)	Monthly	<u>Low CYA</u> : Destruction of chlorine by the UV rays from the sun.	<u>Low CYA</u> : Add Cyanuric acid (1 lb.(0.45 kg) per 5,000 gallons (18,930 liters) increases CYA 25 ppm (mg/L).
		<u>High CYA</u> : Requires more chlorine to maintain proper sanitizer levels. Note: CYA not needed for indoor pools or bromine pools. CYA should be reduced to 30 - 50 ppm (mg/L) for colder climate regions.	<u>High CYA</u> : Partially drain and refill pool with fresh water to dilute. (Diluting will reduce salt. Check and adjust as needed.)
Saturation Index	Monthly	+ 0.3: Water is scale forming. Calcium carbonate is falling out of solution. This rapid buildup of scale may exceed the system's self-cleaning capability and require manual cleaning of the cell.	Balance the pool / spa water as close to an equilibrium of 0 as possible. See "Using the Saturation Index" on page 47.
		- 0.3: Water is corrosive. Water will take away other material it comes in contact with to form a natural balance. These materials can be metallic fixtures, swimwear, etc. Results can also include cloudy water, eye / skin irritation, and poor chlorine effectiveness.	Balance the pool / spa water as close to an equilibrium of 0 as possible. See "Using the Saturation Index" on page 47.
Salt	Monthly	<u>Low Salt</u> : Below 2,400 ppm (mg/L) causes premature cell failure and reduces chlorine production .	<u>Low Salt</u> : Add salt according to digital display on Pool Pilot® unit or salt chart.
		<u>High Salt</u> : Above 6,000 ppm (mg/L) can cause corrosion of metallic fixtures and will taste salty. Note: The Pool Pilot® can safely operate with salt levels up to 35,000 ppm (mg/L).	<u>High Salt</u> : If undesirably high, partially drain and refill the pool with fresh water. (Diluting will reduce CYA. Check and adjust as needed.)

Table 8

10.1.a Chlorine

The desirable form of chlorine is called Free Chlorine. This form of chlorine is responsible for the actual sanitation activity in pools and spas. Free chlorine is highly reactive and, once added to pool / spa water, has a tendency to combine with organic matter in the pool / spa. It quickly attacks pathogens as well as other bather wastes. When chlorine combines, it chemically changes. The chlorine binds to organic matter and is referred to as Combined Chlorine. Combined chlorine is responsible for eye burn and skin irritations. Total Chlorine is the sum of free chlorine and combined chlorine. If a strong chlorine odor is noted, it is due to an excess of combined chlorine. It is important to test total chlorine as well as free chlorine. If there is a difference greater than 0.2 ppm (mg/L), a shock treatment should be initiated.

During peak chlorine demand (summer months, rainy season or heavy bather usage) it may be necessary to increase your chlorine output by increasing your purifier output setting. Conversely, during low chlorine demand, you can decrease your output to a lower setting. For extremely heavy chlorine demand or to boost your chlorine residual levels quickly, you can supplement with any type of chlorine or non-chlorine shock containing potassium monopersulfate.

During cold-water conditions (below 60 °F / 15.6 °C) chlorine demand is reduced significantly. For colder climate regions with sustained low temperatures, contact your local pool professional for proper pool winterizing instructions.

10.1.b pH

pH is a term used to refer to the degree of activity of an acid or base in the water. A low pH, acidic or corrosive water contributes to eye and skin irritation as well as damage to pool equipment. A high pH will result in scaling, cloudy water and ineffective sanitation. Improper pH also contributes to the strong smell, red eyes and dry itchy skin conditions usually associated with “too much chlorine”.

10.1.c Total Alkalinity

Total Alkalinity refers to the ability of the pool water to resist a change in pH. It helps manage or control the pH in the pool. The desired range is 80 to 100 ppm (mg/L). Low alkalinity is aggressive or corrosive and causes the pH readings to fluctuate (pH bounce). High alkalinity may cause cloudy water and scale forming conditions. Your chlorinator does not affect total alkalinity. Factors changing this measure are ancillary chemicals added to the pool and “out of balance” make-up water.

10.1.d Calcium Hardness

Calcium Hardness is a measure of calcium content in the water. If the calcium content is too high, calcium can drop out of solution; forming scale on equipment. A low level will cause the water to become corrosive as the water tries to naturally form equilibrium. This means the water will “leach” minerals from everything it meets. Damage to equipment and unpleasant swimming conditions result. Your chlorinator does not change calcium hardness. Factors changing this measure are ancillary chemicals added to the pool and “out of balance” make-up water.

10.1.e Cyanuric Acid

Cyanuric Acid acts as water “Stabilizer” or “Conditioner”. This chemical goes by either trade name and allows your chlorine residual to last longer by protecting it from the UV rays of the sun. With low cyanuric acid, chlorine can be used up just as quickly as it is generated. Note: For indoor pools, it is not necessary to maintain a stabilizer level to protect the chlorine from the UV rays.

10.2 Using the Saturation Index

This index is used by pool professionals to ensure that your total water chemistry does not fall into a corrosive or scaling condition. Either condition can cause premature damage to the cell, any of your other equipment, as well as your cementitious finish.

The Saturation Index is composed of the following factors:

- pH as tested
- Plus the Temperature factor
- Plus the Calcium Hardness factor
- Plus the Alkalinity factor
- Minus the Total Dissolved Solids factor (in this case the bulk of the dissolved solids are salt)

This is expressed in the formula $SI = pH + TF + CF + AF - TDSF$ and uses the following charts:

TEMPERATURE		TF	CALCIUM HARDNESS		CF	TOTAL ALKALINITY		AF	SALT LEVEL		TDSF
60°F	15.6°F	0.4	150 ppm (mg/L)	1.8	075 ppm (mg/L)	1.9	0000 - 1000 ppm (mg/L)	12.1			
66°F	18.9°F	0.5	200 ppm (mg/L)	1.9	100 ppm (mg/L)	2.0	1001 - 2000 ppm (mg/L)	12.2			
76°F	24.4°F	0.6	250 ppm (mg/L)	2.0	125 ppm (mg/L)	2.1	2001 - 3000 ppm (mg/L)	12.3			
84°F	28.9°F	0.7	300 ppm (mg/L)	2.1	150 ppm (mg/L)	2.2	3001 - 4000 ppm (mg/L)	12.4			
94°F	34.4°F	0.8	400 ppm (mg/L)	2.2	200 ppm (mg/L)	2.3	4001 - 5000 ppm (mg/L)	12.5			
103°F	39.4°F	0.9	600 ppm (mg/L)	2.4	250 ppm (mg/L)	2.4	5001 - 6000 ppm (mg/L)	12.6			

Example:

7.8 = pH as measured

0.7 = Temperature is 84°F (TF)

2.4 = Calcium Hardness is 600 ppm (mg/L) (CF)

2.3 = Total Alkalinity is 200 ppm (mg/L) (AF)

12.4 = Salt is 3,500 ppm (mg/L) (TDSF)

0.8 = Saturation Index.

This water is scale forming and needs to be balanced

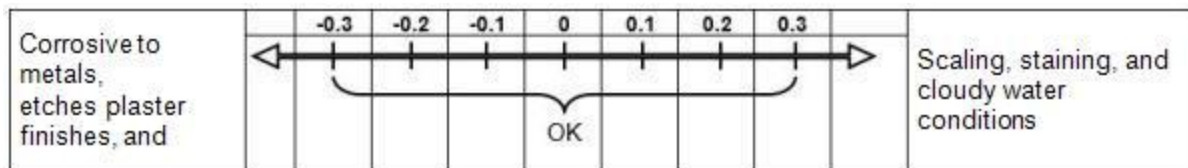

If adjustments need to be made to balance the water, the recommended sequence is as follows:

1. Test and adjust total alkalinity. This may reduce pH so wait at least 8 hours before proceeding.
2. Test again and adjust pH, then
3. Adjust calcium hardness.

10.3 Salt Addition Chart

The following salt charts are included for reference only; once programmed to the correct water volume, the controller will automatically indicate how much salt is required to achieve optimum water salinity.

The salt in the pool is constantly recycled during normal operation. Loss of salt during a swimming season should be minimal. Filter back washing, draining due to rain water overflow, splashing, bathing suit drag out, and leaks are typical ways salt is lost. Salt does not leave the pool when water evaporates.

1. Determine pool/spa volume in Gallons or Liters.
2. Find current salt level in the pool. Many pools will already have a significant salt residual, so always test water before adding salt. (This can be obtained from the control display or by testing water.)
3. Using the Salt Addition Chart below, find the current salt level in the left column.
4. Determine and locate the pool / spa volume in the top column.
5. Locate the intersection of the row and column to find the amount of salt needed to bring the pool to the ideal level.
6. For volumes other than what is shown, use combinations of various columns.

Example:

For an 11,000 gallon (41.640 Liter) pool with a salt level of 500 ppm (mg/L), the column value for 1,000 gallons (3.786 Liter) is added to the column value for 10,000 gallons (37.854 Liter), which gives a total of 230 pounds (104.33 kg) of salt needed to bring your pool salt level up to the ideal level of between 3,000 and 4,500 ppm (mg/L).

Table 10

Pounds (kilograms) of Salt Needed to Attain 3,000 ppm (3.0 g/L)										
Current Salt Level ppm (g/L)	Pool/Spa Volume in Gallons (Liters)									
	1,000 (4,000)	2,000 (8,000)	5,000 (18,000)	10,000 (38,000)	15,000 (56,000)	20,000 (76,000)	25,000 (94,000)	30,000 (114,000)	35,000 (132,000)	40,000 (152,000)
0	25 (11)	50 (23)	125 (57)	250 (113)	375 (170)	500 (227)	626 (284)	751 (340)	876 (397)	1001 (454)
250	23	46	115	229	344	459	573	688	803	917
(0.25)	(10)	(21)	(52)	(104)	(156)	(208)	(260)	(312)	(364)	(416)
500	21	42	104	209	313	417	521	626	730	834
(0.50)	()	(19)	(47)	(95)	(142)	(189)	(236)	(284)	(331)	(378)
750	19	38	94	188	281	375	469	563	657	751
(0.75)	()	(17)	(43)	(85)	(128)	(170)	(213)	(255)	(298)	(340)
1,000	17	33	83	167	250	334	417	500	584	667
(1.0)	(8)	(15)	(38)	(76)	(113)	(151)	(189)	(227)	(265)	(303)
1,250	15	29	73	146	219	292	365	438	511	584
(1.25)	(7)	(13)	(33)	(66)	(99)	(132)	(166)	(199)	(232)	(265)
1,500	13	25	63	125	188	250	313	375	438	500
(1.50)	(6)	(11)	(28)	(57)	(85)	(113)	(142)	(170)	(199)	(227)
1,750	10	21	52	104	156	209	261	313	365	417
(1.75)	(5)	(9)	(24)	(47)	(71)	(95)	(118)	(142)	(166)	(189)
2,000	8	17	42	83	125	167	209	250	292	334
(2.0)	(4)	(8)	(19)	(38)	(57)	(76)	(95)	(113)	(132)	(151)
2,250	6	13	31	63	94	125	156	188	219	250
(2.25)	(3)	(6)	(14)	(28)	(43)	(57)	(71)	(85)	(99)	(113)
2,500	4	8	21	42	63	83	104	125	146	167
(2.50)	(2)	(4)	(9)	(19)	(28)	(38)	(47)	(57)	(66)	(76)
2,750	2	4	10	21	31	42	52	63	73	83
(2.75)	(1)	(2)	(5)	(9)	(14)	(19)	(24)	(28)	(33)	(38)
3,000 (3.0)	Ideal									
3,500 (3.5)	OK for Pool Pilot® Operation – (This is typically the maximum salt level desired by most pool owners/operators, since most people can taste salt levels above this. Greater than 6000 ppm can cause corrosion to metallic objects. If lower salt level is desired, partially drain and refill with fresh water.)									

Pounds (kilograms) of Salt Needed to Attain 4,500 ppm (4.5 g/L)										
Current Salt Level ppm (g/L)	Pool/Spa Volume in Gallons (Liters)									
	1,000 (4,000)	2,000 (8,000)	5,000 (18,000)	10,000 (38,000)	15,000 (56,000)	20,000 (76,000)	25,000 (94,000)	30,000 (114,000)	35,000 (132,000)	40,000 (152,000)
0	38	75	188	375	563	751	938	1126	1314	1501
	(17)	(34)	(85)	(170)	(255)	(340)	(426)	(511)	(596)	(681)
250	35	71	177	354	532	709	886	1063	1241	1418
(0.25)	(16)	(32)	(80)	(161)	(241)	(322)	(402)	(482)	(563)	(643)
500	33	67	167	334	500	667	834	1001	1168	1334
(0.50)	(15)	(30)	(76)	(151)	(227)	(303)	(378)	(454)	(530)	(605)
750	31	63	156	313	469	626	782	938	1095	1251
(0.75)	(14)	(28)	(71)	(142)	(213)	(284)	(355)	(426)	(497)	(567)
1,000	29	58	146	292	438	584	730	876	1022	1168
(1.0)	(13)	(26)	(66)	(132)	(199)	(265)	(331)	(397)	(463)	(530)
1,250	27	54	136	271	407	542	678	813	949	1084
(1.25)	(12)	(25)	(61)	(123)	(184)	(246)	(307)	(369)	(430)	(492)
1,500	25	50	125	250	375	500	626	751	876	1001
(1.5)	(11)	(23)	(57)	(113)	(170)	(227)	(284)	(340)	(397)	(454)
1,750	23	46	115	229	344	459	573	688	803	917
(1.75)	(10)	(21)	(52)	(104)	(156)	(208)	(260)	(312)	(364)	(416)
2,000	21	42	104	209	313	417	521	626	730	834
(2.0)	(9)	(19)	(47)	(95)	(142)	(189)	(236)	(284)	(331)	(378)
2,250	19	38	94	188	281	375	469	563	657	751
(2.25)	(9)	(17)	(43)	(85)	(128)	(170)	(213)	(255)	(298)	(340)
2,500	17	33	83	167	250	334	417	500	584	667
(2.5)	(8)	(15)	(38)	(76)	(113)	(151)	(189)	(227)	(265)	(303)
2,750	15	29	73	146	219	292	365	438	511	584
(2.75)	(7)	(13)	(33)	(66)	(99)	(132)	(166)	(199)	(232)	(265)
3,000	13	25	63	125	188	250	313	375	438	500
(3.0)	(6)	(11)	(28)	(57)	(85)	(113)	(142)	(170)	(199)	(227)
3,250	10	21	52	104	156	209	261	313	365	417
(3.25)	(5)	(9)	(24)	(47)	(71)	(95)	(118)	(142)	(166)	(189)
3,500	8	17	42	83	125	167	209	250	292	334
(3.5)	(4)	(8)	(19)	(38)	(57)	(76)	(95)	(113)	(132)	(151)
3,750	6	13	31	63	94	125	156	188	219	250
(3.75)	(3)	(6)	(14)	(28)	(43)	(57)	(71)	(85)	(99)	(113)
4,000	4	8	21	42	63	83	104	125	146	167
(4.0)	(2)	(4)	(9)	(19)	(28)	(38)	(47)	(57)	(66)	(76)
4,250	2	4	10	21	31	42	52	63	73	83
(4.25)	(1)	(2)	(5)	(9)	(14)	(19)	(24)	(28)	(33)	(38)
4,500 (4.5)	4,500 ppm for optimum chlorine production. OK for Pool Pilot® operation, but if greater than 6,000 ppm, can cause corrosion to metallic objects. If lower salt level is desired, partially drain and refill with fresh water.)									

SECTION 11 - FCC COMPLIANCE

11.1 FCC Compliance

NOTE: This equipment has been tested and found to comply with the limits for a Class B digital device, pursuant to part 15 of the FCC Rules. These limits are designed to provide reasonable protection against harmful interference in a residential installation. This equipment generates uses and can radiate radio frequency energy and, if not installed and used in accordance with the instructions, may cause harmful interference to radio communications. However, there is no guarantee that interference will not occur in a particular installation. If this equipment does cause harmful interference to radio or television reception, which can be determined by turning the equipment off and on, the user is encouraged to try to correct the interference by one or more of the following measures:

- Reorient or relocate the receiving antenna.
- Increase the separation between the equipment and receiver.
- Connect the equipment into an outlet on a circuit different from that to which the receiver is connected.
- Consult the dealer or an experienced radio / TV technician for help.



www.aquacal.com



www.autopilot.com

AquaCal AutoPilot, Inc.
2737 24th Street North
St. Petersburg, Florida 33713
(727) 823-5642